

EN



(IT) Istruzioni d'installazione e funzionamento per l'installatore qualificato

Le istruzioni complete sono disponibili nel seguente link: [www.oventrop.com](http://www.oventrop.com)

<http://www.oventrop.de/qr/136109581#IT>



(ES) Instrucciones de instalación y operación para el instalador especializado

El manual de instrucciones completo se puede consultar en el siguiente link: [www.oventrop.com](http://www.oventrop.com)

<http://www.oventrop.de/qr/136109581#ES>



(RU) Инструкция по монтажу и эксплуатации для специалистов

Полное руководство по эксплуатации можно найти по следующей ссылке: [www.oventrop.com](http://www.oventrop.com)

<http://www.oventrop.de/qr/136109581#RU>



(CS) Montážní a provozní návod pro odborné pracovníky

Úplný návod k obsluze najdete na: [www.oventrop.com](http://www.oventrop.com)

<http://www.oventrop.de/qr/136109581#CS>



11209016

Please read this manual carefully to get the best performance from this unit.  
Please keep this manual carefully.

## Safety advice

Pay attention to the following safety advice in order to avoid danger and damage to people and property.

## Instructions

Attention must be paid to the valid local standards, regulations and directives!

## Information about the product

### Proper usage

The solar controller is designed for use in standard solar thermal and heating systems in compliance with the technical data specified in this manual. Improper use excludes all liability claims.

### CE Declaration of conformity

The product complies with the relevant directives and is therefore labelled with the CE mark.



#### Note:

Strong electromagnetic fields can impair the function of the controller.

- Make sure the controller as well as the system are not exposed to strong electromagnetic fields.

**Subject to technical change. Errors excepted.**

## Target group

These instructions are exclusively addressed to authorised skilled personnel.

Only qualified electricians should carry out electrical works.

Initial installation must be effected by the system owner or qualified personnel named by the system owner.

## Description of symbols

**WARNING!** Warnings are indicated with a warning triangle!  
→ **They contain information on how to avoid the danger described.**



Signal words describe the danger that may occur, when it is not avoided.

- **WARNING** means that injury, possibly life-threatening injury, can occur.
- **ATTENTION** means that damage to the appliance can occur.



#### Note:

Notes are indicated with an information symbol.

- Arrows indicate instruction steps that should be carried out.

## Disposal

- Dispose of the packaging in an environmentally sound manner.
- Dispose of old appliances in an environmentally sound manner. On request we will take back your old appliances bought from us and guarantee an environmentally sound disposal of the devices.

## Contents

<b>1</b>	<b>Overview</b> .....	<b>4</b>	<b>7</b>	<b>Solar</b> .....	<b>20</b>
<b>2</b>	<b>Installation</b> .....	<b>5</b>	7.1	Basic solar settings.....	20
2.1	Mounting .....	5	7.2	Solar optional functions.....	25
2.2	Electrical connection .....	5	7.3	Solar expert menu .....	30
2.3	Data communication / Bus .....	6	<b>8</b>	<b>Arrangement</b> .....	<b>31</b>
<b>3</b>	<b>Operation and function</b> .....	<b>7</b>	8.1	Optional functions .....	31
3.1	Buttons .....	7	<b>9</b>	<b>HQM</b> .....	<b>38</b>
3.2	Selecting menu points and adjusting values .....	7	<b>10</b>	<b>Basic settings</b> .....	<b>39</b>
<b>4</b>	<b>Initial commissioning</b> .....	<b>11</b>	<b>11</b>	<b>SD card</b> .....	<b>39</b>
4.1	Basic systems and hydraulic variants.....	13	<b>12</b>	<b>Manual mode</b> .....	<b>41</b>
4.2	Overview of relay and sensor allocation .....	14	<b>13</b>	<b>User code</b> .....	<b>41</b>
4.3	SD card slot.....	17	<b>14</b>	<b>In-/Outputs</b> .....	<b>42</b>
<b>5</b>	<b>Step-by-step parameterisation</b> .....	<b>17</b>	14.1	Modules .....	42
5.1	Menu structure .....	18	14.2	Inputs.....	43
<b>6</b>	<b>Status</b> .....	<b>19</b>	14.3	Outputs .....	44
6.1	Solar .....	19	14.4	PWM profiles .....	46
6.2	Arrangement .....	19	<b>15</b>	<b>Troubleshooting</b> .....	<b>48</b>
6.3	Messages.....	19	<b>16</b>	<b>Index</b> .....	<b>51</b>
6.4	Meas./Balance values .....	19			
6.5	Service .....	19			

## 1 Overview

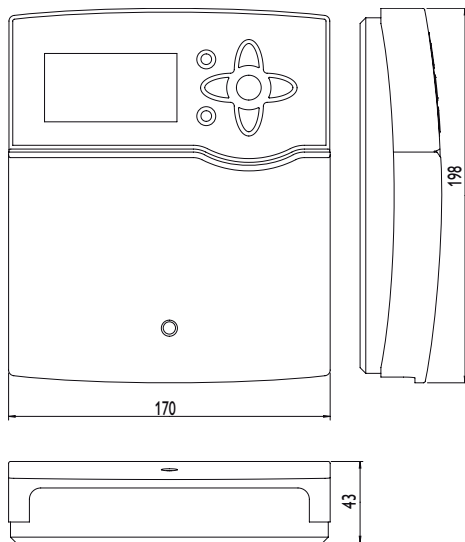

### Technical data

**Housing:** plastic, PC-ABS and PMMA

**Protection type:** IP 20/EN 60529

**Protection class:** I

**Ambient temp.:** 0 ... 40 °C

**Dimensions:** 198 × 170 × 43 mm

**Mounting:** wall mounting, also suitable for mounting into patch panels

**Display:** full graphic display, control lamp (directional pad) and background illumination

### Operation:

7 push buttons at the front of the housing

**Functions:** system controller for solar systems. Functions such as:  $\Delta T$  control, pump speed control, heat quantity measurement, operating hours counter for the solar pump, tube collector function, thermostat function, store loading in layers, priority logic, heat dump function, circulation function, PWM pump control, function control.

**Inputs:** 8 (9) inputs for Pt1000, Pt500, or KTY temperature sensors (7 of them can be used for remote controls), 1 V40 impulse inputs, inputs for 2 digital Grundfos Direct Sensors™ (1x VFD, 1x RPD), 1 input for a CS10 irradiation sensor

**Outputs:** 4 semiconductor relays, 1 potential-free relay, 2 PWM outputs (convertible to 0-10 V)

**Interfaces:** S-Bus, SD card slot

**Power supply:** 100 ... 240 V~, 50 ... 60 Hz

### Switching capacity per relay:

1 (1) A 240 V~ (semiconductor relay)

4 (1) A 240 V~ (potential-free relay)

4 (1) A 24 V= (potential-free relay)

**Total switching capacity:** 4 A 240 V~

**Fuse:** T4A

**Standby power consumption:** < 1 W

**Mode of operation:** type 1.Y

**Degree of pollution:** 2

**Rated impulse voltage:** 2.5 kV

**Supply connection:** type Y attachment

## 2 Installation

### 2.1 Mounting

The device must only be located in dry interior rooms. The controller must additionally be supplied from a double pole switch with contact gap of at least 3 mm. Please pay attention to separate routing of sensor cables and mains cables.

In order to mount the device to the wall, carry out the following steps:

- Unscrew the cross-head screw from the cover and remove it along with the cover from the housing.
- Mark the upper fastening point on the wall. Drill and fasten the enclosed wall plug and screw leaving the head protruding.
- Hang the housing from the upper fastening point and mark the lower fastening points (centres 150mm).
- Insert lower wall plugs.
- Fasten the housing to the wall with the lower fastening screw and tighten.
- Carry out the electrical wiring in accordance with the terminal allocation, (see chap. 2.2).
- Put the cover on the housing.
- Attach with the fastening screw.



#### Note:

Strong electromagnetic fields can impair the function of the controller.

- Make sure the controller as well as the system are not exposed to strong electromagnetic fields.

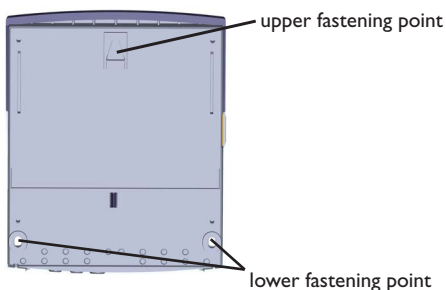
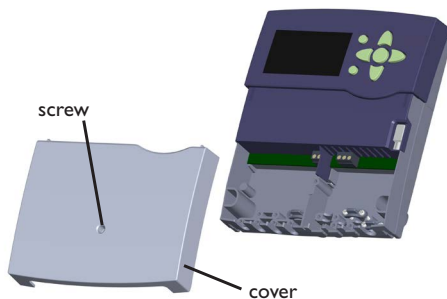

#### WARNING! Electric shock!



Upon opening the housing, live parts are exposed!

- **Always disconnect the device from power supply before opening the housing!**

### 2.2 Electrical connection



#### Note:

Connecting the device to the power supply must always be the last step of the installation!

The controller is equipped with 5 **relays** in total to which loads such as pumps, valves, etc. can be connected:

Relays 1... 4 are semiconductor relays, designed for pump speed control.

Conductor R1... R4

Neutral conductor N (common terminal block)

Protective earth conductor  $\oplus$  (common terminal block)

Relay 5 is a potential-free relay:

R5-A = normally open contact

R5-M = centre contact

Relay 5 is a potential-free relay:

Connections to the R5 terminals can be made with either polarity.

#### WARNING! ESD damage!



Electrostatic discharge can lead to damage to electronic components!

- **Take care to discharge properly before touching the inside of the device! To do so, touch a grounded surface such as a radiator or tap!**



#### Note:

The minimum pump speed must be set to 100% when non-speed-controlled devices such as valves are connected.

**WARNING! Electric shock!**

Upon opening the housing, live parts are exposed!

→ **Always disconnect the device from power supply before opening the housing!**

**Note:**

For more details about the initial commissioning procedure see page 11.

Depending on the product version, mains cables and sensor cables are already connected to the device. If that is not the case, please proceed as follows:

The **temperature sensors** (S1 to S8) have to be connected to the terminals S1 ... S8 and GND (either polarity).

The S9 terminal is an impulse input for an impulse flowmeter or a flow switch.

An impulse flowmeter can be connected to the terminals S9/V40 and GND (either polarity).

Connect the irradiation sensor to the terminals CS10 and GND with correct polarity. To do so, connect the cable marked GND to the GND common terminal block, the cable marked CS to the terminal marked CS10.

In the menu, the irradiation sensor will be indicated as CS10.

The connector marked PWM contains the 2 PWM/0-10 V control signal outputs for high-efficiency pumps.

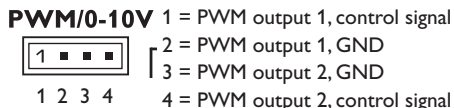

In the In-/Outputs menu, relays can be allocated to the PWM outputs.

Connect the **digital Grundfos Direct Sensors™** to the VFD and RPD inputs.

The controller is supplied with power via a mains cable. The power supply of the device must be 100 ... 240V~ (50 ... 60 Hz).

The mains connection is at the following terminals:

- Neutral conductor N
- Conductor L
- Protective earth conductor ⊕ (common terminal block)

**WARNING! Electric shock!**

L' is a fused contact permanently carrying voltage.

→ **Always disconnect the device from power supply before opening the housing!**

**2.3 Data communication / Bus**

The controller is equipped with an **S-Bus** or data transfer with and energy supply to external modules. The connection is carried out at the two terminals marked **S-Bus** and **GND** (either polarity). One or more S-Bus modules can be connected via this data bus, such as:

- OVENTROP CS-BS Datalogger
- Regtronic EM Extension Module

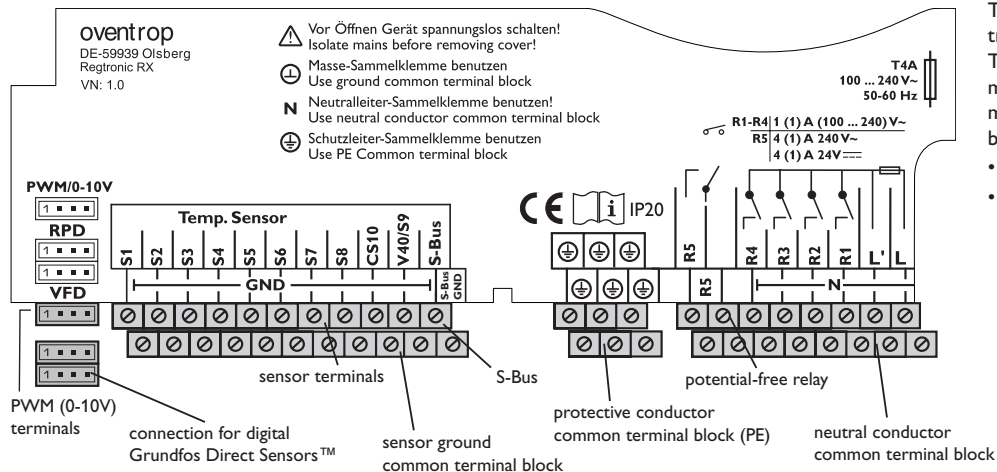

### 3 Operation and function

#### 3.1 Buttons

The controller is operated via the 7 buttons next to the display. They have the following functions:

Button 1 - scrolling upwards

Button 3 - scrolling downwards

Button 2 - increasing adjustment values

Button 4 - reducing adjustment values

Button 5 - confirming

Button 6 - entering the status menu/ chimney sweeper mode (system-dependent)

Button 7 - escape button for changing into the previous menu

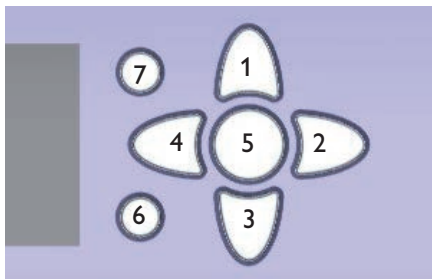

#### 3.2 Selecting menu points and adjusting values

During normal operation of the controller, the display is in the main menu. If no button is pressed for a few seconds, the display illumination goes out.

Press any key to reactivate the display illumination.

→ In order to scroll through a menu or to adjust a value, press either buttons 1 and 3 or buttons 2 and 4.

→ To open a sub-menu or to confirm a value, press button 5.

→ To enter the status menu, press button 6 – unconfirmed adjustments will not be saved.

→ To enter the previous menu, press button 7 – unconfirmed adjustments will not be saved.

If no button has been pressed within a couple of minutes, the adjustment is cancelled and the previous value is retained.

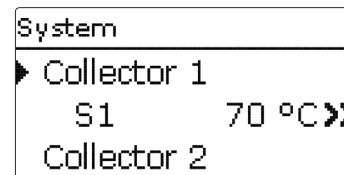

If the symbol » is shown behind a menu item, pressing button 5 will open a new sub-menu.

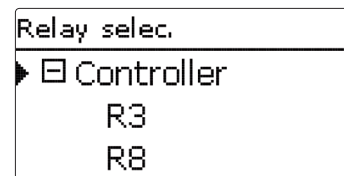

If the symbol ⊞ is shown in front of a menu item, pressing button 5 will open a new sub-menu. If it is already opened, a ⊞ is shown instead of the ⊞.

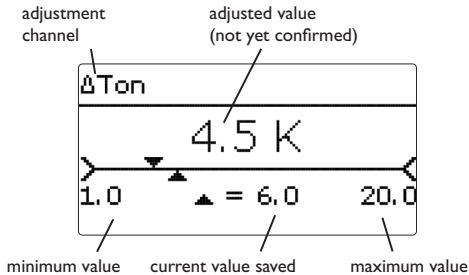

Values and adjustments can be changed in different ways:

Numeric values can be adjusted by means of a slide bar. The minimum value is indicated to the left, the maximum value to the right. The large number above the slide bar indicates the current adjustment. By pressing buttons **2** or **4** the upper slide bar can be moved to the left or to the right.

Only after the adjustment has been confirmed by pressing button **5** will the number below the slide bar indicate the new value. The new value will be saved if it is confirmed by pressing button **5** again.

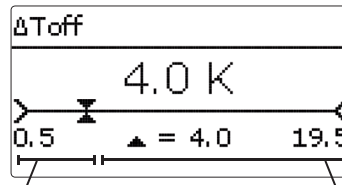

When 2 values are locked against each other, they will display a reduced adjustment range depending on the adjustment of the respective other value. In this case, the active area of the slide bar is shortened, the inactive area is indicated as a dotted line. The indication of the minimum and maximum values will adapt to the reduction.

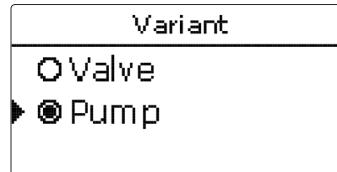

If only one item of several can be selected, they will be indicated with "radio buttons". When one item has been selected, the radio button in front of it is filled.

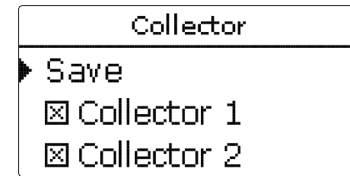

If more than one item of several can be selected, they will be indicated with checkboxes. When an item has been selected, an x appears inside the checkbox.



### 3.2.1 Adjusting the timer

When the **Timer** option is activated, a timer is indicated in which time frames for the function can be adjusted.

First of all, an overview of the current adjustments is displayed. For each day of the week there is an overview display. The display can be switched back and forth between the different days by pressing buttons **2** or **4**.

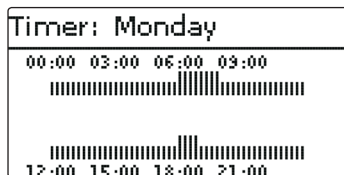

In order to adjust the timer, press button **5**.

First, individual or all days of the week can be selected for timer adjustment.

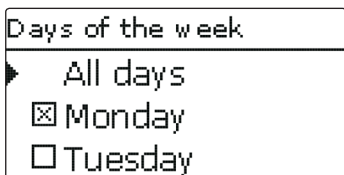

The last menu item after the list of days is **Continue**. If Continue is selected, the **Edit timer** menu opens, in which the time frames can be adjusted.

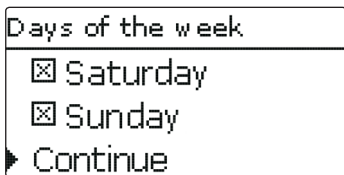

#### Adding a time frame:

The time frames can be adjusted in steps of 15 min. In order to add an active time frame, proceed as follows:

➔ Move the cursor to the desired starting point of the time frame by pressing buttons **2** and **4**. Confirm the starting point of the time frame by pressing button **1**.

➔ Move the cursor to the desired ending point of the time frame by pressing buttons **2** and **4**.

➔ The end of a time frame can be determined by pressing button **5**.

➔ In order to add another time frame, repeat the last three steps.

**i Note:** In order to adjust a 24 h time frame, press button **1** once during the adjustment process.

➔ Press button **5** again to get back to the overview of current adjustments.

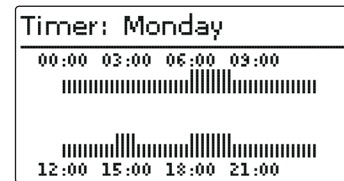
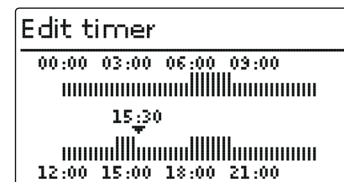
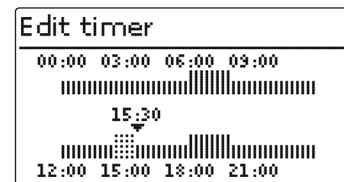
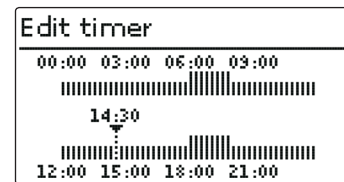

## Removing a time frame:

In order to remove an active time frame, proceed as follows:

- Determine the point from which on the time frame is to be removed by pressing button **3**.
- Move the cursor to the desired ending point of the time frame by pressing buttons **2** and **4**.
- In order to conclude removing the time frame, press button **5** upon reaching the desired ending point.
- Press button **5** again to get back to the overview of current adjustments.
- In order to leave the timer, press button **7**.

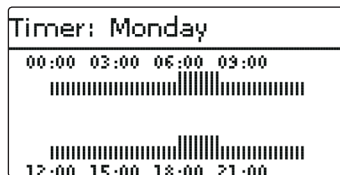
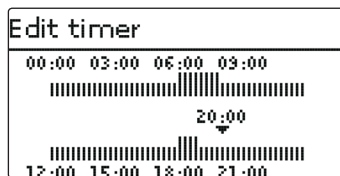
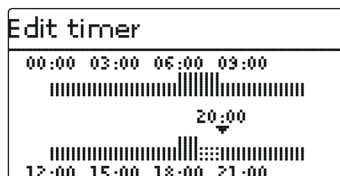
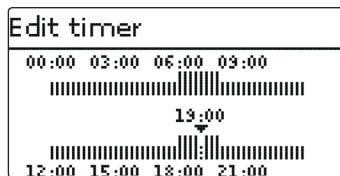

## 4 Initial commissioning

When the hydraulic system is filled and ready for operation, connect the controller to the mains.

The controller runs an initialisation phase in which the directional pad flashes red.

When the controller is commissioned for the first time or when it is reset, it will run a commissioning menu after the initialisation phase. The commissioning menu leads the user through the most important adjustment channels needed for operating the system.

### Commissioning menu

The commissioning menu consists of the channels described in the following.

#### 1. Language:

- Adjust the desired menu language.

Language
▶ Deutsch
English
Francais

#### 2. Units:

- Adjust the desired temperature unit.

Temp. Unit
<input type="radio"/> °F
▶ <input checked="" type="radio"/> °C

- Adjust the desired volume unit.

Flow Unit
<input type="radio"/> Gallons
▶ <input checked="" type="radio"/> Litre

- Adjust the desired pressure unit.

Press. Unit
<input type="radio"/> psi
▶ <input checked="" type="radio"/> bar

- Adjust the desired energy unit.

Energy Unit
<input type="radio"/> BTU
▶ <input checked="" type="radio"/> Wh
<input type="radio"/> kWh

### 3. Daylight savings time adjustment:

- Activate or deactivate the automatic daylight savings time adjustment.

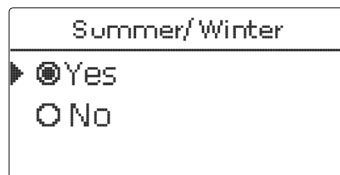

### 4. Time:

- Adjust the clock time. First of all adjust the hours, then the minutes.



### 5. Date:

- Adjust the date. First of all adjust the year, then the month and then the day.

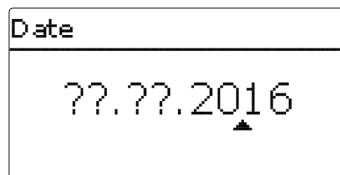

### 6. Selection of the solar system:

- Adjust the desired solar system (number of collectors and stores, hydraulic variants).

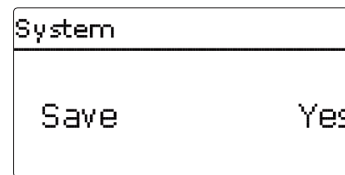
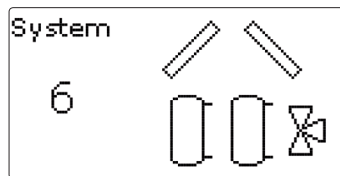

### 7. Completing the commissioning menu:

After the system has been selected, a security enquiry appears. If the security enquiry is confirmed, the adjustments are saved.

- In order to confirm the security enquiry, press button (5).
- In order to reenter the commissioning menu channels, press button (7). If the security enquiry has been confirmed, the controller is ready for operation and should enable an optimum system operation.

The adjustments carried out during commissioning can be changed anytime in the corresponding adjustment channel.

## 4.1 Basic systems and hydraulic variants

### System

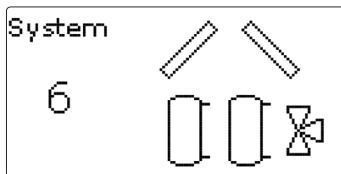

System 1: 1 collector field	- 1 store
System 2: 1 collector field	- 1 store with store loading in layers
System 3: 1 collector field	- 2 stores
System 4: east- /west collectors	- 1 store
System 5: east- /west collectors	- 1 store with store loading in layers
System 6: east- /west collectors	- 2 stores

The controller is pre-programmed for 6 basic systems. The selection depends on the number of heat sources (collector fields) and heat sinks (stores). Factory setting is system 1.

The controller allocates corresponding relay and sensor settings for each system. The allocations of all combinations are shown in chap. 4.2.

## 4.2 Overview of relay and sensor allocation

### System 1

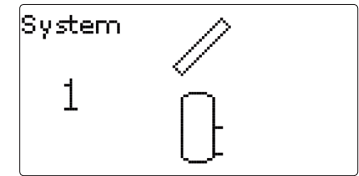
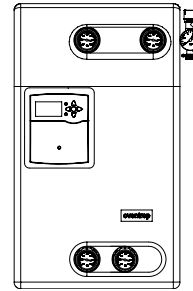
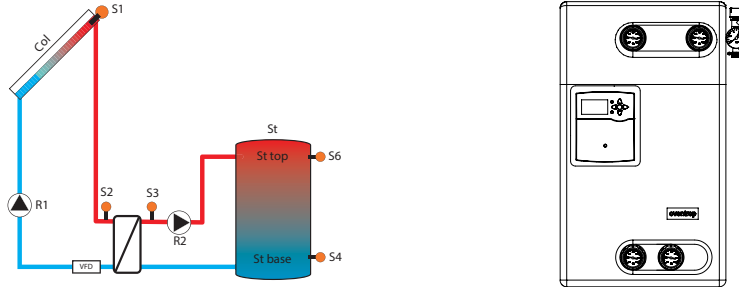



### Relay/sensor allocation

	1	2	3	4	5	6	7	8	9
Relay	Collector pump	Secondary circuit	Optional function	Optional function	Optional function	-	-	-	-
Sensor	Collector	Primary circuit	Secondary circuit	Store base	Free	Store top	Free	Free	Free

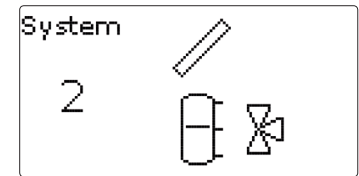
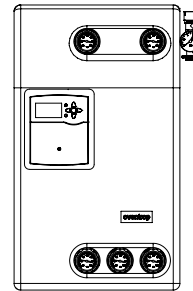
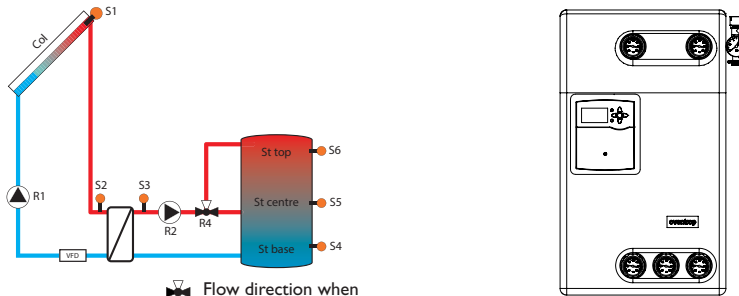
### System 2



 Flow direction when normally open  

### Relay/sensor allocation

	1	2	3	4	5	6	7	8	9
Relay	Collector pump	Secondary circuit	Optional function	3-port valve	Optional function	-	-	-	-
Sensor	Collector	Primary circuit	Secondary circuit	Store base	Store centre	Store top	Free	Free	Free

### System 3

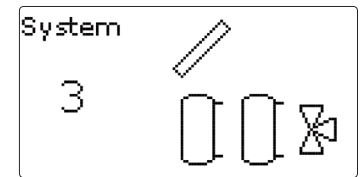
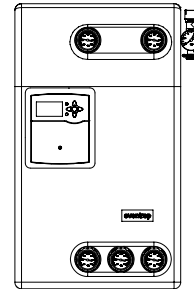
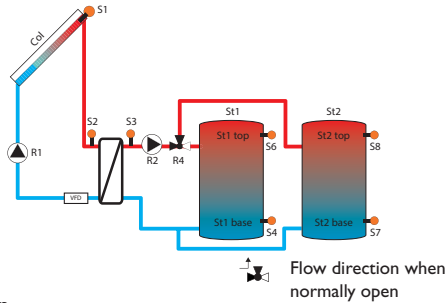

### Relay/sensor allocation

	1	2	3	4	5	6	7	8	9
Relay	Collector pump	Secondary circuit	Optional function	3-port valve	Optional function	-	-	-	-
Sensor	Collector	Primary circuit	Secondary circuit	Store 1 base	Free	Store 1 top	Store 2 base	Store 2 top	Free

### System 4

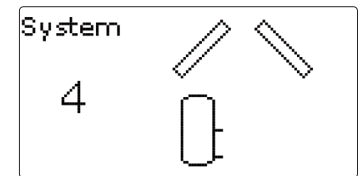
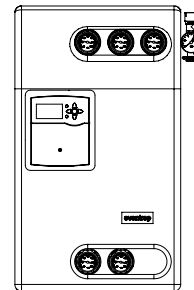
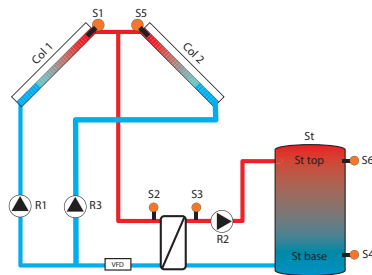

### Relay/sensor allocation

	1	2	3	4	5	6	7	8	9
Relay	Collector pump 1	Secondary circuit	Collector pump 2	Optional function	Optional function	-	-	-	-
Sensor	Collector 1	Primary circuit	Secondary circuit	Store base	Collector 2	Store top	Free	Free	Free

## System 5

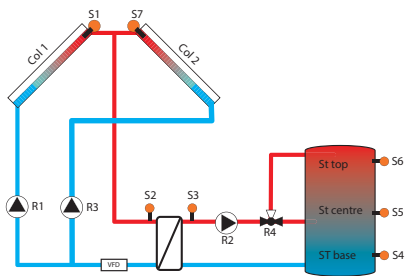

Flow direction when normally open

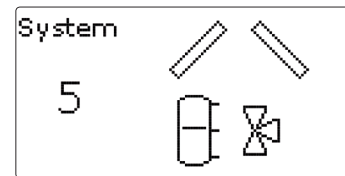
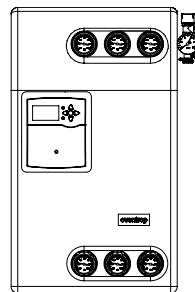

### Relay/sensor allocation

	1	2	3	4	5	6	7	8	9
Relay	Collector pump 1	Secondary circuit	Collector pump 2	3-port valve	Optional function	-	-	-	-
Sensor	Collector 1	Primary circuit	Secondary circuit	Store base	Store centre	Store top	Collector 2	Free	Free

## System 6

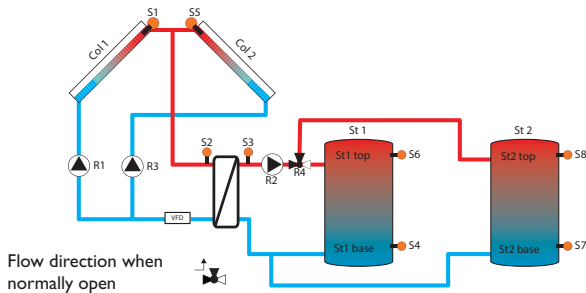

Flow direction when normally open

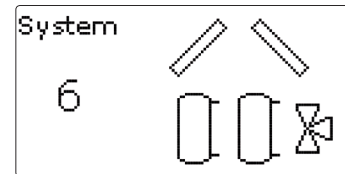
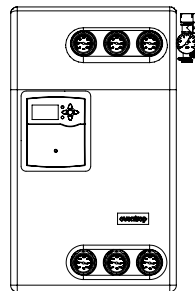

### Relay/sensor allocation

	1	2	3	4	5	6	7	8	9
Relay	Collector pump 1	Secondary circuit	Collector pump 2	3-port valve	Optional function	-	-	-	-
Sensor	Collector 1	Primary circuit	Secondary circuit	Store 1 base	Collector 2	Store 1 top	Store 2 base	Store 2 top	Free



### 4.3 SD card slot

The controller is equipped with an SD card slot.

With an SD card, the following functions can be carried out:

- Store measurement and balance values onto the SD card. After the transfer to a computer, the values can be opened and visualised, e. g. in a spreadsheet.
- Store adjustments and parameterisations on the SD card and, if necessary, retrieve them from there.
- Download firmware updates from the Internet and install them on the controller.



For more information about using an SD card, see chap. 11 on page 39.

## 5 Step-by-step parameterisation

### 1. Running the commissioning menu

The commissioning menu is run after the first connection and after every reset. It will request the following basic adjustments:

- Menu language
- Temperature unit
- Volume unit
- Pressure unit
- Energy unit
- Time
- Date
- Solar system

At the end of the commissioning menu, a security enquiry follows. If the security enquiry is confirmed, the adjustments are saved.

For further information about the commissioning menu see page 11.

### 2. Registering sensors

If impulse flowmeters, Grundfos Direct Sensors™ and/or external extension modules are connected, these have to be registered in the In-/Outputs menu.

For further information about the registration of modules and sensors see page 42.

### 3. Activating solar optional functions

The basic solar system has been adjusted during commissioning. Now, optional functions can be selected, activated and adjusted.

Free relays can be allocated to optional functions which require a relay. The controller suggests the numerically smallest free relay.

Sensors can be allocated to more than one function.

For further information about the solar optional functions see page 25.

### 4. Activating optional arrangement functions

Now, optional functions for the non-solar part of the arrangement can be selected, activated and adjusted.

Free relays can be allocated to optional functions which require a relay. The controller suggests the numerically smallest free relay.

Sensors can be allocated to more than one function.

For further information about the optional arrangement functions see page 31.

## 5.1 Menu structure

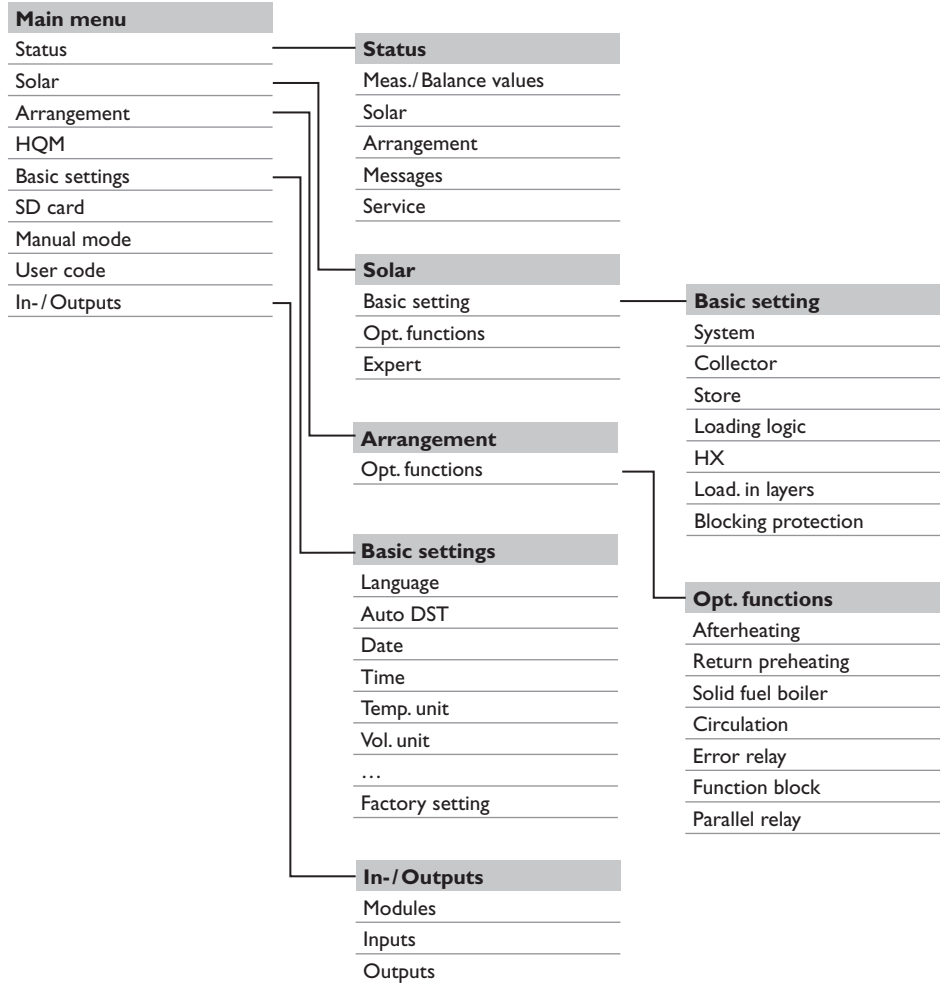

The menu items and adjustment values selectable are variable depending on adjustments already made. The figure only shows an exemplary excerpt of the complete menu in order to visualise the menu structure.

## 6 Status

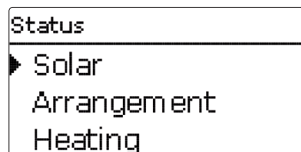

In the **Status** menu of the controller, the status messages for every menu area can be found.

### 6.1 Solar

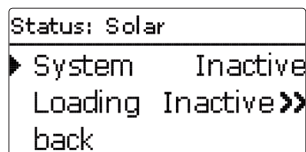

In the **Status/Solar** menu, the status of the solar system, the solar loading and the selected optional functions are indicated.

### 6.2 Arrangement

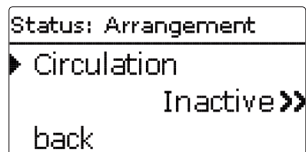

In the **Status/Arrangement** menu, the status of the selected optional functions is indicated.

### 6.3 Messages

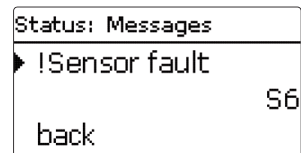

In the **Status/Messages** menu, error and warning messages that have not been acknowledged are indicated.

During normal operation, the message **Everything OK** is indicated.

A line break or short circuit in a sensor line is indicated as **!Sensor fault**.

In order to acknowledge an error message, the Status/Messages menu has to be entered.

### 6.4 Meas./Balance values

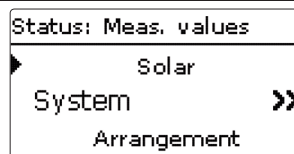

In the **Status/Meas./Balance values** menu, all current measurement values as well as a range of balance values are displayed. Some of the menu items can be selected in order to enter a sub-menu.

Additionally, all optional functions selected, the operating hours counter as well as activated heat quantity measurements are displayed.

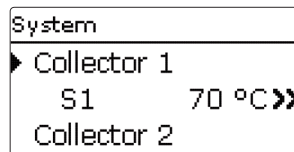

If, for example, **Solar/System** is selected, a sub-menu with the sensors and relays allocated to the solar system opens. In the sub-menu, the current temperatures and the current pump speed are displayed. When a line with a measurement value is selected, another sub-menu will open.

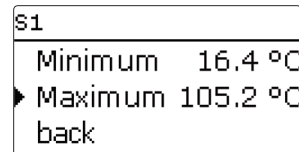

If, for example, S1 is selected, a sub-menu indicating the minimum and maximum values will open.

When the item Chart is selected, a progression chart appears.

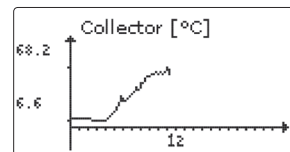

The progression chart shows the development of the temperature at the corresponding sensor over the last 24 hours. Press buttons **2** and **4** to switch back and forth between a chart of the current day and one of the day before.

### 6.5 Service

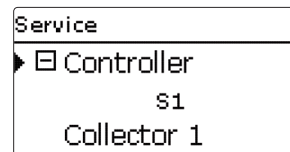

In the **Status/Service** menu, each sensor and relay is indicated with the component or function it has been allocated to. For free sensors and relays, **Free** is indicated.

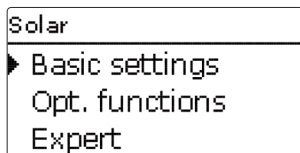

In this menu, all adjustments for the solar part of the arrangement can be made. The Solar menu consists of the following sub-menus:

- Basic setting
- Optional functions

### 7.1 Basic solar settings

In this menu, all basic settings for the solar part of the arrangement can be adjusted.

In this menu, the hydraulic system, which is the basis for the arrangement, can be adjusted. The setting is divided into systems.

Both system and variant have usually been adjusted during commissioning. If the setting is changed later on, all adjustments for the solar part of the arrangement are set back to their factory settings.

If the change causes the solar system to require a relay that has been allocated to an arrangement function before, all adjustments made in the non-solar function will be set back to their factory settings as well.

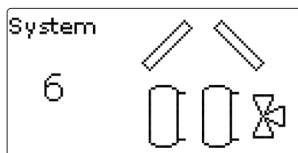

The system can be selected by the corresponding system number. The corresponding number of stores and collector fields is visualised on the display.

For an overview of the basic systems see chap. 4.2 on page 14.

The controller supports up to 2 collector fields, 2 solar stores and a store being loaded in layers.

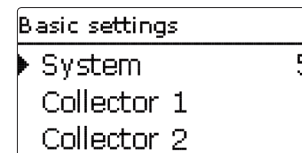

The following items in the **Solar/Basic settings** menu will adjust to the system selected.

### Collector (1/2)

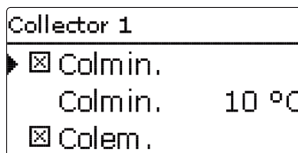

In systems with 2 collector fields, 2 separate menu items (**Collector 1** and **Collector 2**) are displayed instead of **Collector**.

For each collector field, a collector minimum limitation and a collector emergency shutdown temperature can be adjusted.

### Solar/Basic settings/Collector (1/2)

Adjustment channel	Description	Adjustment range/selection	Factory setting
Colmin.	Minimum collector temperature	10 ... 90 °C	10 °C
Colem.	Collector emergency temperature	80 ... 130 °C	130 °C

## Store (1/2)

Store	
▶ $\Delta T_{on}$	6.0 K
$\Delta T_{off}$	4.0 K
$\Delta T_{set}$	10.0 K

### Solar/Basic settings/Store (1/2)

Adjustment channel	Description	Adjustment range/selection	Factory setting
$\Delta T_{on}$	Switch-on temperature difference	1.0 ... 20.5 K	6.0 K
$\Delta T_{off}$	Switch-off temperature difference	0.5 ... 20 K	4.0 K
$\Delta T_{set}$	Set temperature difference	1.5 ... 30.0 K	10.0 K
Stset	Store set temperature	4 ... 60 °C	45 °C
Stmax	Maximum store temperature	48 ... 95 °C	60 °C
Priority	Priority	1, 2	1 (system-dependent)
HysSt	Hysteresis maximum store temperature	0.1 ... 10.0 K	2.0 K
Rise	Rise	1.0 ... 20.0 K	2.0 K
tMin	Minimum runtime	0 ... 300	180
Min speed	Minimum speed	20 ... 100 %	30 %
Deactivated	Blocked for solar loading	Yes, No	No

In systems with 2 or more stores, the corresponding number of separate menu items (**Store 1** to **Store 2**) is displayed instead of **Store**.

For each store, an individual  $\Delta T$  control, a set and a maximum temperature, the priority (in multi-store systems), a hysteresis, a rise value, a minimum runtime and a minimum pump speed can be adjusted.

In system 1, the parameter Stset is relevant for the solar optional function AH suppression only:

If the store temperature falls below the Stset value, the AH suppression relay will be deactivated. Thus, the parameter Stset forms the lower comfort limit.

In multi-store-systems with differing Store set/Maximum store temperatures, all stores are loaded up to their **Stset** temperatures first (according to their priority and the store sequence control). Only if all stores have exceeded **Stset** will they be loaded up to their Stmax temperatures, again according to their priority and the store sequence control.



#### Note:

The maximum store temperature cannot be adjusted lower than the store set temperature.

## Heat exchanger

Ext. HX	
▶ $\Delta T_{on}$	10.0 K
$\Delta T_{off}$	5.0 K
Overrun	2 min



### Note:

The switch-on temperature difference must be at least 0.5K higher than the switch-off temperature difference.

## Solar/Basic settings/HX

Adjustment channel	Description	Adjustment range/selection	Factory setting
$\Delta T_{on}$	Switch-on temperature difference	1.0 ... 20.0K	10.0K
$\Delta T_{off}$	Switch-off temperature difference	0.5 ... 19.5K	5.0K
Overrun	Overrun time	0 ... 15 min	2 min
Minimum speed	Minimum speed	30 ... 100%	30%

The relay (R2) is energised if one of the selected stores can be loaded and there is a temperature difference between the sensor of the corresponding store and the solar flow (S2).

The relay is switched off if this temperature difference falls below the adjusted switch-off difference.

Sensor S2 is always used as the reference sensor.

The heat exchanger is protected by a non-adjustable antifreeze function.

When the temperature at the reference sensor ext. HX (S2) falls below the non-adjustable antifreeze temperature (10°C), the controller will activate the secondary pump at 100 % speed. The antifreeze function will use heat from the store with the highest temperature. When all stores have reached 10°C, the secondary pump will be switched off. If the temperature at the reference sensor ext. HX (S2) exceeds the antifreeze temperature by 2 K, the antifreeze function will be switched off.

The heat exchanger antifreeze function works independently from solar loading.

## Blocking protection

Basic settings	
HX	
▶ <input checked="" type="checkbox"/> Blocking protectio	
back	

In order to protect the pumps against blocking after a standstill, the controller is equipped with a blocking protection function. This function switches on the store loading pump every day at 00:00 a.m. for 10 s at 100 % speed.

Scheme 1	Scheme 2	Scheme 3	Scheme 4
R1, R2	R1, R2, R4	R1, R2, R4	R1, R2, R3

Scheme 5	Scheme 6
R1, R2, R3, R4	R1, R2, R3, R4

## Store loading in layers

Load. in layers	
Targ. temp.	59 °C
ΔTon	5.0 K
ΔToff	3.0 K



### Note:

This function is available in systems 2 and 5 only.

## Solar/Basic settings/Load. in layers

Adjustment channel	Description	Adjustment range/selection	Factory setting
Target temp.	Target temperature	15 ... 85 °C	59 °C
ΔTon	Store loading in layers switch-on difference	1.0 ... 20.5 K	5.0 K
ΔToff	Store loading in layers switch-off difference	0.5 ... 20.0 K	3.0 K
ΔTset	Set temperature difference	1 ... 30 K	20 K
Rise	Rise	1 ... 20 K	5 K
ΔTtooHigh	ΔT too high error message option	Activated, Deactivated	Activated
ΔT	Temperature difference	10 ... 60 K	50 K
Time	Time	1 ... 30 min	20 min

Store loading in layers is used for keeping the DHW zone of the store at a certain temperature level, in order to delay a possible afterheating for as long as possible.

The 3-port valve (R4) is normally open towards the lower store zone. It will switch to the upper store zone when all of the following conditions are fulfilled:

- the temperature difference ΔTon between the sensors S3 and S5 has exceeded the switch-on temperature difference
- the temperature at S3 has reached the adjustable target temperature
- the temperature at S5 has fallen by at least 1 K below the adjustable target temperature

As long as the temperature at sensor S5 is below the target temperature, both pumps will run at minimum speed.

When the temperature at sensor S3 exceeds the target temperature by the adjustable rise value, the speed of the primary pump will be adapted. If the temperature again increases by the rise value, the speed of the secondary pump will be adapted, too. Each temperature increase by the rise value will lead to an alternating adaptation of the primary and secondary pump speeds.

If the temperature at sensor S3 decreases by the rise value and the non-adjustable hysteresis (0.5 × Rise), the speed will be adapted accordingly.

When the target temperature is exceeded at sensor S5, both pumps will be controlled according to regular pump speed control. The 3-port valve will be set back to its normally open condition.

The ΔT too high option is used for monitoring the temperature difference between the collector sensor and the sensor in the primary circuit. The message Check hydraulics! is shown if solar loading has been carried out for the adjustable period Time with a temperature difference higher than ΔT. Normal operation is not aborted or inhibited, but the system should be checked for the cause of the warning.



### Note:

The target temperature and the maximum store temperature are locked against each other.



### Note:

In order to avoid incorrect error messages, only activate the **ΔT too high** option when the difference between the collector emergency temperature and the maximum store temperature is sufficiently high.

## Loading logic

Load. logic	
▶ Load. break	2 min
Circ.	15 min
<input type="checkbox"/> Break speed	

In systems with 2 stores, loading logic adjustments can be made in this menu.

In system 1, only the menu item **Pump delay** will be available.

### Solar/Basic settings/Loading logic

Adjustment channel	Description	Adjustment range/selection	Factory setting
Load. break	Loading break time	1... 5 min	2 min
Circ.	Circulation time	1... 60 min	15 min
Pause speed	Pause speed	Yes, No	No
Speed	Pause speed	30... 100%	30%
Pump delay	Pump delay	Yes, No	No
Delay	Delay time	5... 600 s	15 s

### Store sequence control:

If the priority store cannot be loaded, the subordinate store next in priority is checked. If useful heat can be added, it will be loaded for the circulation time (**Circ.** – factory setting 15 min). After this, the loading process stops and the controller monitors the increase in collector temperature during the loading break time **Load. break**. If it increases by 2K, the break time starts again to allow the collector to gain more heat. If the collector temperature does not increase sufficiently, the subordinate store will be loaded again for the **Circ. time** as before.

As soon as the switch-on condition of the priority store is fulfilled, it will be loaded. If the switch-on condition of the priority store is not fulfilled, loading of the subordinate store will be continued. If the priority store reaches its maximum temperature, store sequence control will not be carried out.

If store sequence control is active and the system switches to load the priority store, the parameter **Load. break** also acts as a stabilisation time, during which the switch-off condition is ignored while the system operation is stabilising.



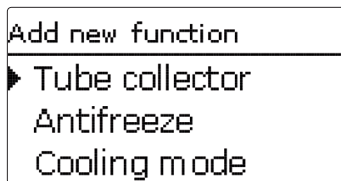

In this menu, additional functions can be selected and adjusted for the solar part of the arrangement.

By selecting **Add new function**, different pre-programmed functions can be selected. The optional functions are available as long as free relays are available.

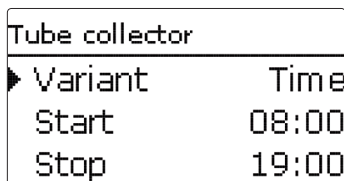

When a function is selected, a sub-menu opens in which all adjustments required can be made.

With this menu item, a relay and, if necessary, certain system components can be allocated to the function.

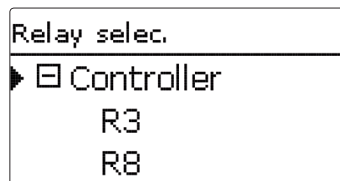

The menu item **Relay selec.** is available in almost all optional functions. Therefore, it will not be explained in the individual function descriptions.

With this menu item, a relay can be allocated to the function. All free relays are available for selection.

In the sub-menu **Controller**, all free relays of the controller are displayed. If external modules are connected and registered, their relays will be displayed in corresponding sub-menus.

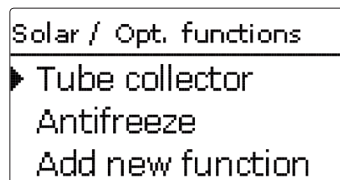

When a function has been selected and adjusted, it will appear in the **Opt. functions** menu above the menu item **Add new function**.

This allows an easy overview of functions already activated.

An overview about which sensor has been allocated to which component and which relay has been allocated to which function is given in the **Status/Service** menu.

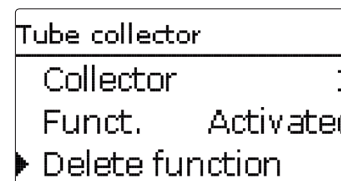

At the end of each optional function sub-menu, the menu items **Function** and **Delete function** are available.

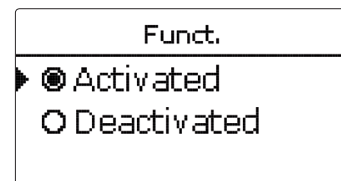

With the menu item **Function**, an optional function already selected can be temporarily deactivated or re-activated respectively. All adjustments remain stored, the allocated relays remain occupied and cannot be allocated to another function.

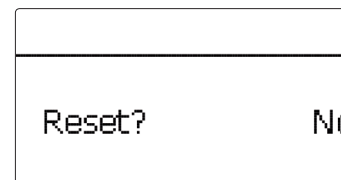

If the menu item **Delete function** is confirmed by pressing button **5**, a security enquiry appears. The setting can be changed between Yes and No by pressing buttons **2** and **4**. If Yes has been selected and confirmed by pressing button **5**, the function is deleted and available under **Add new function** again. The corresponding relays are available again.

## Tube collector function

Tube collector	
▶ Variant	Time
Start	08:00
Stop	19:00

### Solar/Opt. functions/Add new function/Tube collector

Adjustment channel	Description	Adjustment range/selection	Factory setting
Variant	Sensor-/Time-controlled	Sensor,Time	Time
Start	Start time frame	00:00 ... 23:00	08:00
Stop	Stop time frame	00:30 ... 23:30	19:00
Run	Pump runtime	5 ... 600 s	30 s
Pause	Pause	1 ... 60 min	30 min
Delay	Pump delay	5 ... 600 s	15 s
Collector	Collector field	system dependent	system dependent
Funct.	Activation/ Deactivation	Activ./Deactivated	Activated



#### Note: Multi-store systems

If the tube collector function is activated, the speed of the solar pump will decrease to the minimum speed during the loading break time. The solar loading of the subordinate store will continue.



#### Note:

In 2-collector systems, the tube collector function will affect the inactive collector field only. The solar pump of the active collector field will remain switched on until the switch-off conditions are fulfilled.

This function is used for improving the switch-on behaviour in systems with non-ideal sensor positions (e.g. with some tube collectors). In 2-collector systems, the tube collector function is available for the second collector field as well.

The function can operate either time- or sensor-controlled.

#### Time-controlled

This function operates within an adjusted time frame. It activates the collector circuit pump for an adjustable runtime between adjustable standstill intervals in order to compensate for the delayed temperature measurement.

If the runtime is set to more than 10s, the pump will run at 100% for the first 10s of the runtime. For the remaining runtime, the pump will run at the adjusted minimum speed.

#### Sensor-controlled

If the controller detects an increase in collector temperature by 2K compared to the previously stored collector temperature, the collector circuit pump will be switched on for about 30s in order to detect the heat transfer fluid temperature. If the switch-on condition between the collector and the store is exceeded during the runtime of the solar pump, the controller will automatically switch to solar loading.

In the Delay channel, a switch-on delay for the pump can be adjusted. This ensures that e.g. a check valve in the collector circuit has completely opened before the pump starts running.



#### Note:

If the collector sensor is defective or the collector is blocked, this function is suppressed or switched off.

## Antifreeze function

Antifreeze	
▶ Frost on	4 °C
Frost off	6 °C
Collector	1

The Antifreeze function activates the system when the collector temperature falls below the adjusted Antifreeze switch-on temperature. This will protect the fluid against freezing or coagulating.

When the collector temperature exceeds the adjustable Antifreeze switch-off temperature, the function is switched off.

Heat will be extracted from the stores according to the adjusted order. When all stores have reached their minimum temperature of 5 °C, the function becomes inactive.

If the function is active, the pump runs at its maximum relative speed.

In systems with east-/west collectors 2 separate menus will be displayed.

### Solar/Opt. functions/Add new function/Antifreeze

Adjustment channel	Description	Adjustment range/selection	Factory setting
Frost on	Antifreeze switch-on temperature	-40 ... +15 °C	+4 °C
Frost off	Antifreeze switch-off temperature	-39 ... +16 °C	+6 °C
Collector	Collector field	system dependent	system dependent
Store (1,2)	Store succession order	system dependent	system dependent
Funct.	Activation/Deactivation	Activ./Deactivated	Activated

## Afterheating suppression

AH suppress.	
▶ Relay	R3
Store	1
<input type="checkbox"/> Stset	

Relay selec.	
▶ Free	
<input checked="" type="checkbox"/> Controller	R3

The Afterheating suppression blocks the conventional afterheating of a store that is currently in solar loading.

This function is activated if a previously selected **Store** is being loaded by solar heat.

Solar loading means that store loading is only carried out for energy supply and not for cooling purposes etc.

The afterheating suppression can directly control the "boiler blocking" input of a heat generator. If Arrangement/Opt. functions/AH suppress. has been activated, the afterheating suppression can also directly control the afterheating (= heating demand) of the controller. In order to do so, select the virtual relay "Demand" in the Arrangement/Opt. functions/AH suppress./Relay channel. The afterheating will then only demand heat from the boiler when the store temperature falls below the switch-on temperature and the store is not being loaded by solar loading.

When the Stset option is activated and the store temperature falls below the value adjusted for Stset in the Solar/Basic settings/Store menu, the AH suppress. relay will be deactivated. Thus, the parameter Stset forms the lower comfort limit.

### Solar/Opt. functions/Add new function/AH suppress.

Adjustment channel	Description	Adjustment range/selection	Factory setting
Relay	Reference relay	system dependent	system dependent
Store	Store selection	system dependent	system dependent
Stset	Set temperature	Yes, No	No
Funct.	Activation/Deactivation	Activ./Deactivated	Activated

## Cooling mode

In the Cooling mode menu, different cooling functions are available. They can be used for keeping the solar system operational for a longer time during strong solar irradiation.

The collector cooling variant aims to prevent the collectors from stagnating. The system cooling variant will become active when the temperature difference between the collector and the store exceeds the switch-on temperature difference. Thus, at an early stage it aims to keep the complete system continuously operative. The store cooling option can be activated additionally in both variants.

For this purpose, the adjusted maximum store temperatures can be exceeded. The store order for this overloading can be adjusted. Additionally, each individual store can be excluded from this function.

Two different variants are available for the cooling mode: the system cooling and the collector cooling.

The variant is set to Off by default, i. e. none of the variants is active.

Cooling mode	
▶ Var.	Off
Store 1	-
St cooling	No

## System cooling:

If the system cooling variant has been selected and the adjustable switch-on temperature difference is exceeded between collector and store, store loading is continued even if the corresponding maximum temperature is exceeded, but only up to the emergency shutdown temperature (95 °C, non-adjustable). Store loading continues until all stores have reached the emergency shutdown temperature or until the adjustable switch-off temperature difference is reached.

## Collector cooling:

If the collector cooling variant has been selected, store loading is continued or reactivated when the collector maximum temperature is exceeded.

Store loading continues until all stores have reached the emergency shutdown temperature or until the collector temperature falls below the collector maximum temperature by at least 5 K.

In 2-collector systems, separate adjustments can be made for each collector field.

The control logic regards collector cooling operation as solar loading. The adjusted values for delay, minimum runtime, etc. remain valid.

In addition to the cooling mode, store cooling is available.

## Store cooling:

When the store cooling function is activated, the controller aims to cool down the store during the night in order to prepare it for solar loading on the following day.

When the store cooling function is activated, the solar pump is switched on if the maximum store temperature is exceeded and the collector temperature falls below the store temperature. The solar pump remains active until the store temperature falls below the adjusted maximum store temperature.

The store order for the cooling is the same as in the overheating through system or collector cooling.

The holiday function works like the store cooling function but aims to cool the store down to the adjustable holiday cooling temperature during times without DHW consumption in order to prepare it for solar loading on the following day. This function can only be activated if the store cooling function is activated.

The holiday function can either be activated manually when a period with no DHW consumption begins, or a time frame, during which the function is to become active, can be set in advance. If manual is selected, an input can be allocated to the function. When a switch is connected to the allocated input, it will act as an on/off switch for the holiday function.

Cooling mode	
▶ <input checked="" type="checkbox"/> Holiday	
Activ.	Timer
On 17.11.2010	

## Solar/Opt. functions/Add new function/Cooling mode

Adjustment channel	Description	Adjustment range/selection	Factory setting
Variant	Cooling logic variant	Col. cool, Syst. cool., Off	Off
Tcolmax.	Collector maximum temperature	70 ... 120 °C	100 °C
Store (1,2)	Store succession order	system dependent	system dependent
St cooling	Store cooling	Yes, No	No
$\Delta T_{on}$	Switch-on temperature difference	1.0 ... 30.0 K	20.0 K
$\Delta T_{off}$	Switch-off temperature difference	0.5 ... 29.5 K	15.0 K
Holiday	Holiday function	Yes, No	No
Activation	Activation mode	Manual, Timer	Timer
On	Holiday function switch-on date	Dates up to 31.12.2099	Current date
Off	Holiday function switch-off date	Dates up to 31.12.2099	Current date
Input	Holiday function switch input	system dependent	system dependent
Stmax (1,2)	Maximum store temperature Holiday function	4 ... 95 °C	40 °C
Funct.	Activation/Deactivation	Activ./Deactivated	Activated

## Heat dump

Surplus heat diss.	
Relay	R4
Tcol.	110 °C
Funct.	Activated



### Note:

The collector switch-on temperature is blocked against the collector emergency temperature by 10K.

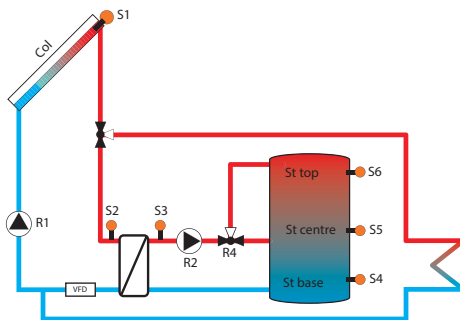

The heat dump function can be used for directing excess heat generated by strong solar irradiation to an external heat exchanger (e. g. fan coil) in order to prevent the collectors from overheating.

The allocated relay is energised with 100%, if the collector temperature reaches the adjusted switch-on temperature. If the collector temperature falls by 5 K below the adjusted collector overtemperature, the relay will be switched off.

If one of the store temperatures exceeds its respective maximum temperature by more than 5 K while the heat dump function is active, the function is deactivated and an error message appears. If the temperature at the lower sensor of the corresponding store falls below the maximum store temperature, the heat dump function is released again.

## Solar/Opt. functions/Add new function/Heat dump

Adjustment channel	Description	Adjustment range/selection	Factory setting
Relay	Relay selection	system dependent	system dependent
Tcol.	Switch-on collector temperature	40 ... 120 °C	120 °C
Funct.	Activation/Deactivation	Activ./Deactivated	Activated

## 7.3 Solar expert menu

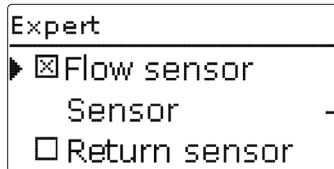

The Expert menu is only available when the expert user code has been entered. In the expert menu, a flow and a return sensor can be selected and allocated. The allocated sensors are then used to detect the switch-off condition.



**Note:** Because of the special hydraulics, this function will not work properly in systems with 2 collector fields.

### Solar/Expert

Adjustment channel	Description	Adjustment range/selection	Factory setting
Flow sensor	Flow sensor option	Yes, No	No
Sensor	Flow sensor selection	system dependent	-
Return sensor	Return sensor option	Yes, No	No
Sensor	Return sensor selection	system dependent	-

### Overloading protection

#### Solar/Expert/Overload. protection

Adjustment channel	Description	Adjustment range/selection	Factory setting
Overload. protection	Overloading protection	Yes, No	Yes
Emergency temperature	Emergency temperature	60... 95 °C	90 °C
SFB Off	Solid fuel boiler off	Yes, No	No



**Note:** This function is available in systems 3 and 6 only.



**Note:** When this function is activated, the maximum store temperature cannot be adjusted to a value higher than 90 °C.

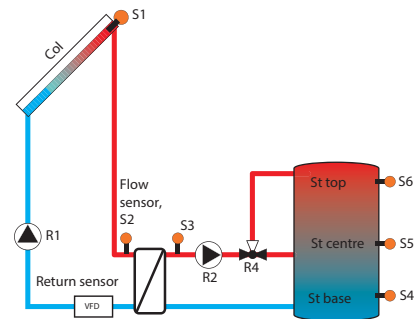

Example of flow and return sensor positions

The Overloading protection is used for protecting a store which is not supposed to be loaded from being overheated in the case of a blocked 3-port valve.

When the overloading protection function is activated and the first store is being loaded, monitoring of the second store starts. When, during the loading of the first store, the temperature of the second store exceeds the adjusted Emergency temperature, overloading protection will become active. Both the solar and the secondary pump will be switched off. The error message "Check 3-port valve!" will be indicated in the Status/Messages menu.

If the temperature of the second store falls by 5K below the emergency temperature, both the solar and the secondary pump will be switched on.

If the SFB Off option is activated and the solid fuel boiler relay is switched on, the overloading protection will become inactive.

## 8 Arrangement

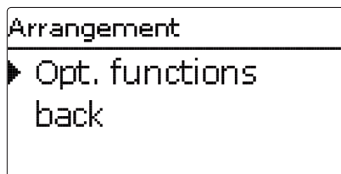

In this menu, all adjustments for the non-solar part of the arrangement can be made.

A range of optional functions can be selected and adjusted.

### 8.1 Optional functions

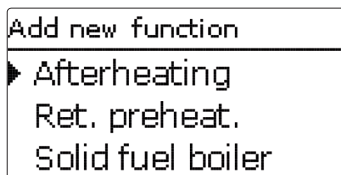

In this menu, additional functions can be selected and adjusted for the arrangement.

By selecting **Add new function**, different pre-programmed functions can be selected. The optional functions are available as long as free relays are available.

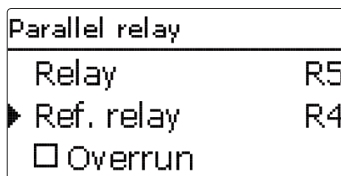

When a function is selected, a sub-menu opens in which all adjustments required can be made. With this sub-menu, a relay and, if necessary, certain system components can be allocated to the function.

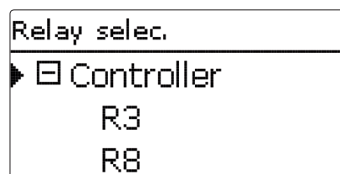

The menu item **Relay selec.** is available in all optional functions. Therefore, it will not be explained in the individual function descriptions.

With this menu item, a relay can be allocated to the function. All free relays are available for selection.

In the sub-menu **Controller**, all free relays of the controller are displayed. If external modules are connected and registered, their relays will be displayed in corresponding sub-menus.

When a new function is activated, the next free sensor inputs will automatically be allocated in a numerical order. This allocation can be changed at any time.

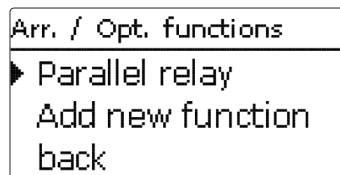

When a function has been selected and adjusted, it will appear in the **Opt. functions** menu above the menu item **Add new function**.

This allows an easy overview of functions already activated.

An overview about which sensor has been allocated to which component and which relay has been allocated to which function is given in the **Status/Service** menu.

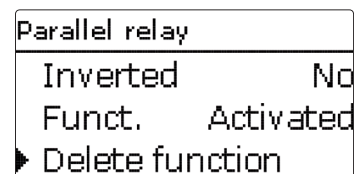

At the end of each optional function sub-menu, the menu items **Function** and **Delete function** are available.

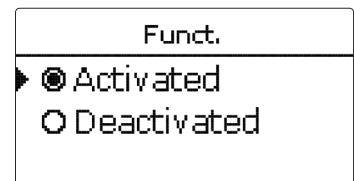

With the menu item **Function**, an optional function already selected can be temporarily deactivated or re-activated respectively. All adjustments remain stored, the allocated relays remain occupied and cannot be allocated to another function.

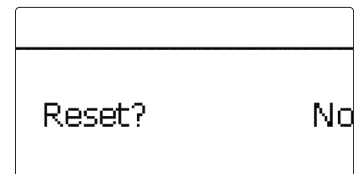

If the menu item **Delete function** is confirmed by pressing button **5**, a security enquiry appears. The setting can be changed between Yes and No by pressing buttons **2** and **4**. If Yes has been selected and confirmed by pressing button **5**, the function is deleted and available under **Add new function** again. The corresponding relays are available again.

## Afterheating

### Arrangement/Opt. functions/Add new function/Afterheating

Adjustment channel	Description	Adjustment range/selection	Factory setting
Relay	Relay selection	system dependent	system dependent
AH-On	Afterheating switch-on temperature	0 ... 100 °C	40 °C
AH-Off	Afterheating switch-off temperature	0 ... 100 °C	45 °C
Sensor	Sensor selection	system dependent	system dependent
Timer	Timer	00:00 ... 23:59	-
Funct.	Activation/Deactivation	Activ./Deactivated	Activated

The Afterheating function is used to heat the upper store zone if necessary. It works independently from solar loading and can be activated by the user.

As soon as the temperature at the allocated store reference sensor falls below the switch-on temperature, the allocated relay will be switched on.

If the temperature exceeds the switch-off temperature, the relay allocated switches off.

### Error relay

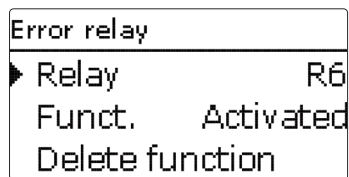

The Error relay function can be used for operating a relay in the case of an error. Thus, e. g. a signalling device can be connected in order to signal errors.

If the error relay function is activated, the allocated relay will operate when a sensor fault occurs.

### Arrangement/Opt. functions/Add new function/Error relay

Adjustment channel	Description	Adjustment range/selection	Factory setting
Relay	Relay selection	system dependent	system dependent
Funct.	Activation/Deactivation	Activ./Deactivated	Activated



## Solid fuel boiler

Solid fuel boiler	
Relay	R5
Sen. Boiler	S7
Sen. Store	S9

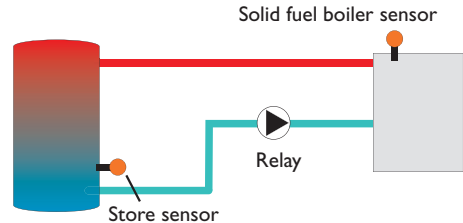

The Solid fuel boiler function can be used for transferring heat from a solid fuel boiler to a store.

The allocated relay is energised when all switch-on conditions are fulfilled:

- the temperature difference between the allocated sensors has exceeded the switch-on temperature difference
- the temperature at the solid fuel boiler sensor has exceeded the minimum temperature
- the temperature at the store sensor has fallen below the maximum temperature

When the Set temperature difference is exceeded, pump speed control starts. For every deviation of 2K, the pump speed will be adjusted by 10%.

### Arrangement/Opt. functions/Add new function/Solid fuel boiler

Adjustment channel	Description	Adjustment range/selection	Factory setting
Relay	Relay selection	system dependent	system dependent
Sen. Boiler	Solid fuel boiler sensor selection	system dependent	system dependent
Sen. Store	Store sensor selection	system dependent	system dependent
$\Delta T_{on}$	Switch-on temperature difference	1.0 ... 30.0K	6.0K
$\Delta T_{off}$	Switch-off temperature difference	0.5 ... 29.5K	4.0K
$\Delta T_{set}$	Set temperature difference	1.5 ... 40.0K	10.0K
Min speed	Minimum speed	30 ... 100%	100%
Tmax St.	Maximum temperature	10 ... 95 °C	60 °C
Tmin boiler	Minimum temperature	10 ... 95 °C	60 °C
Funct.	Activation/Deactivation	Activ./Deactivated	Activated

## Circulation

Circulation	
Relay	R9
Type	Thermal
Sensor	S10

The Circulation function can be used for controlling a circulation pump.

For the control logic, 3 different variants are available:

- Thermal
- Timer
- Thermal + Timer

If one of the variants is selected, the corresponding adjustment channels will appear.

### Thermal

The temperature at the allocated sensor is monitored. The allocated relay switches on when the temperature falls below the adjusted switch-on temperature. If the temperature exceeds the switch-off temperature, the relay switches off.

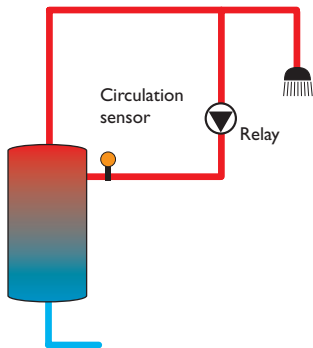

### Timer

The relay is switched on during the adjusted time frames, outside of them it switches off. For information on how to adjust the timer, see below.

#### Thermal + Timer

The relay operates when the switch-on conditions of both above mentioned variants are fulfilled.

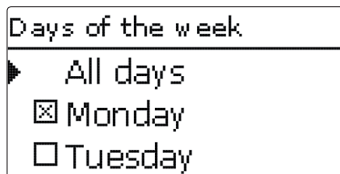
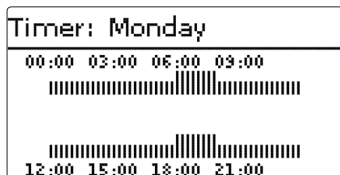

When the **Timer**, or the **Therm. + Timer** variant is activated, a timer is indicated in which time frames for the function can be adjusted. For more information on timer adjustment, see pages 9 and 10.

First of all, an overview of the current adjustments is displayed. For each day of the week there is an overview display. The display can be switched back and forth between the different days by pressing buttons **2** or **4**.

In order to adjust the timer, press button **5**.

First the individual days of the week or all days of the week can be selected. The last menu item after the list of days is **Continue**. If **Continue** is selected, the **Edit timer** menu opens, in which the time frames can be adjusted.

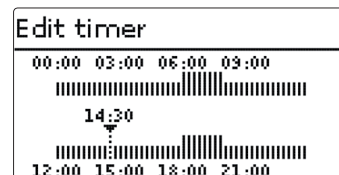

The time frames can be adjusted in steps of 15 min. By pressing buttons **2** or **4** the cursor can be moved along the time line.

Select the starting point of the time frame by pressing button **1**. The end of a time frame can be determined by pressing button **3**.

### Arrangement / Opt. functions / Add new function / Circulation

Adjustment channel	Description	Adjustment range / selection	Factory setting
Relay	Relay selection	system dependent	system dependent
Type	Variant	Therm.+Timer,Timer,Thermal	Thermal
Sensor	Circulation sensor selection	system dependent	system dependent
Ton	Switch-on temperature	10 ... 59 °C	40 °C
Toff	Switch-off temperature	11 ... 60 °C	45 °C
Timer	Timer	-	-
Funct.	Activation / Deactivation	Activ./ Deactivated	Activated

## Return preheating

Ret. preheat.	
Relay	R8
Sen. Return	S7
Sen. HS	S8

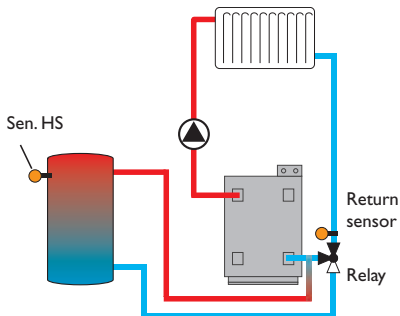

The Return preheating function can be used for transferring heat from a heat source to the heating circuit return.

The allocated relay is energised when both switch-on conditions are fulfilled:

- the temperature difference between the allocated sensors has exceeded the switch-on temperature difference
- the temperature at the outdoor temperature sensor has fallen below the adjusted outdoor temperature

With the summer switch-off option, the return preheating can be suppressed outside the heating period.

## Arrangement/Opt. functions/Add new function/Return preheating

Adjustment channel	Description	Adjustment range/selection	Factory setting
Relay	Relay selection	system dependent	system dependent
Sen. Return	Return sensor selection	system dependent	system dependent
Sen. HS	Heat source sensor selection	system dependent	system dependent
Ton	Switch-on temperature difference	2.0 ... 30.0K	6.0K
Toff	Switch-off temperature difference	1.0 ... 29.0K	4.0K
Summer off	Summer switch-off option	Yes, No	No
Sensor	Outdoor sensor selection	system dependent	system dependent
Toff	Switch-off temperature	10 ... 60°C	20°C
Funct.	Activation/Deactivation	Activ./Deactivated	Activated

## Function block

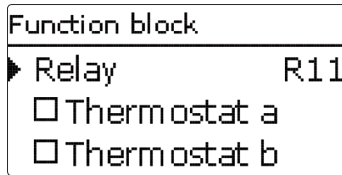

In addition to the pre-defined optional functions, function blocks consisting of thermostat functions, timer and differential functions are available. With the help of these function blocks, further components, resp. functions can be controlled.

To each function block, sensors and free relays can be allocated. Sensors already in use can be allocated again without impeding their control functions.

Within a function block the functions are interconnected (AND gate). This means that the conditions of all the activated functions have to be fulfilled (e. g. thermostat and timer) for switching the allocated relay. As soon as one condition is not fulfilled, the relay is switched off.

### Thermostat function

The switch-on condition for the thermostat function is considered fulfilled when the adjusted switch-on temperature (**Th(x)on**) is reached.

It is considered unfulfilled when the adjusted switch-off temperature (**Th(x)off**) is reached.

Allocate the reference sensor in the **Sensor** channel. Adjust the maximum temperature limitation / thermostat function for afterheating with  $Th(x)off > Th(x)on$  and the minimum temperature limitation with  $Th(x)on > Th(x)off$ .

The temperatures cannot be set to an identical value.

### $\Delta T$ function

The relay allocated to the function block is switched on as soon as the adjusted switch-on temperature difference ( $\Delta T(x)on$ ) is reached. It is switched off as soon as the adjusted switch-off temperature difference ( $\Delta T(x)off$ ) is reached.

### Timer

The relay allocated to the function block will be switched on when the operation time is within the adjusted time frame.

### Reference relay

Up to 5 reference relays can be selected.

Whether the reference relays are to be switched in series (AND) or in parallel (OR) can be adjusted in the **Mode** channel.

#### OR mode

If at least one of the reference relays is active, the switch-on condition for the function block is considered fulfilled. The switching conditions of all other activated functions of the function block have to be fulfilled as well.

#### AND mode

If all reference relays are active, the switch-on condition for the function block is considered fulfilled. The switching conditions of all other activated functions of the function block have to be fulfilled as well.

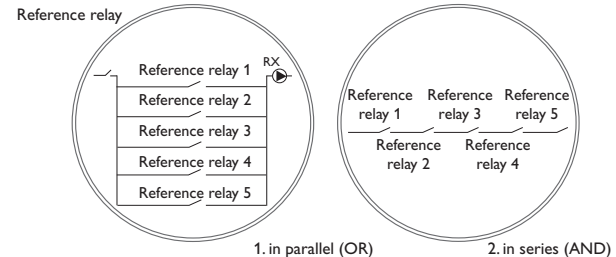
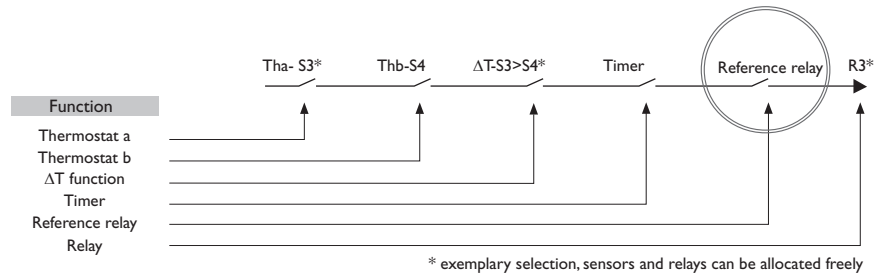

1. in parallel (OR)

2. in series (AND)

## Arrangement / Opt. functions / Add new function / Function block

Adjustment channel	Description	Adjustment range / selection	Factory setting
Relay	Relay	system dependent	system dependent
Thermostat a	Thermostat a	Yes, No	No
Th-a on	Switch-on temperature Thermostat a	-40 ... 250 °C	40 °C
Th-a off	Switch-off temperature Thermostat a	-40 ... 250 °C	45 °C
Sensor	Sensor thermostat a	system dependent	system dependent
Thermostat b	Thermostat b	Yes, No	No
Th-b on	Switch-on temperature Thermostat b	-40 ... 250 °C	40 °C
Th-b off	Switch-off temperature Thermostat b	-40 ... 250 °C	45 °C
Sensor	Sensor thermostat b	system dependent	system dependent
ΔT function	Differential function	Yes, No	No
ΔTon	Switch-on temperature difference	1.0 ... 50.0K	5.0K
ΔToff	Switch-off temperature difference	0.5 ... 49.5K	3.0K
ΔTset	Set temperature difference	3 ... 100K	10.0K
Min speed	Loading pump minimum speed	30 ... 100%	30%
Sen. Source	Heat source sensor	Controller S1 ... S8, Gd1	system dependent
Sen. Sink	Heat sink sensor	Controller S1 ... S8, Gd1	system dependent
Timer	Timer	-	-
Days of the week	Day selection	All days, Monday ... Sunday, Continue	-
Timer	Time frame adjustment	00:00 ... 23:45	-
Reference relay	Reference relay	Yes, No	No
Funct.	Activation / Deactivation	Activ./ Deactivated	Activated

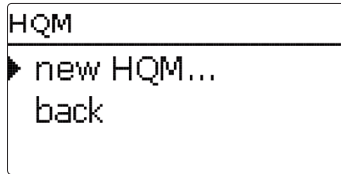

In the HQM menu, an internal heat quantity measurement can be activated and adjusted.

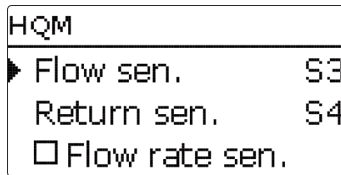

In the heat quantity measurement menu, all adjustments required for the heat quantity measurement can be made.

For heat quantity measurement, the flow and the return temperature as well as the flow rate are required. The heat quantity measurement can be carried out with a fixed flow rate value or with a flow rate sensor. If a relay has been allocated, heat quantity measurement will only take place when the allocated relay is switched on.



#### Note:

In order to enable heat quantity measurement, one sensor each must be allocated for the flow and for the return.

In the menu item **Flow rate sensor**, an impulse input or, if available, a Grundfos Direct Sensor™ can be selected. Grundfos Direct Sensors™ are only available if they have been previously registered in the In-/Outputs menu. The impulse rate must be adjusted in that menu as well.

In the adjustment channel **Fluid type** the heat transfer fluid must be selected. If either Propylene glycol or Ethylene glycol is selected, the adjustment channel **Ratio** is indicated in which the antifreeze ratio of the heat transfer fluid can be adjusted.

When the **Alternative unit** is activated, the controller will convert the heat quantity into the quantity of fossil fuels (coal, oil or gas) saved, or the CO<sub>2</sub> emission saved respectively. The alternative **Unit** can be selected.

A **Conversion factor** must be adjusted for the calculation. The conversion factor depends on the arrangement in use and has to be determined individually.

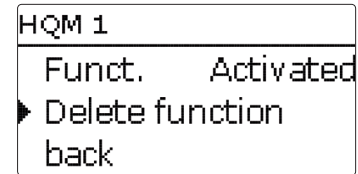

To deactivate the heat quantity measurement, select the menu item **Delete function** at the bottom of the menu.

#### HQM/new HQM...

Adjustment channel	Description	Adjustment range/selection	Factory setting
Flow sen.	Flow sensor selection	system dependent	system dependent
Return sen.	Return sensor selection	system dependent	system dependent
Flow rate sen.	Flow rate sensor option	Yes, No	No
Flow rate sen.	Flow rate sensor selection	-	-
Flow r...	Flow rate (only if Flow rate sen. = No)	1.0 ... 500.0 l/min	3.0 l/min
Relay	Relay selection	system dependent	system dependent
Fluid type	Heat transfer fluid	Tyfocon LS, Propylene glycol, Ethylene glycol, Water	Water
Alternative unit	Alternative unit option	Yes, No	No
Unit	Alternative display unit	Coal, Gas, Oil, CO <sub>2</sub>	CO <sub>2</sub>
Factor	Conversion factor	0.01 ... 100.00	0.50
Funct.	Activation/Deactivation	Activ./Deactivated	Activated

## 10 Basic settings

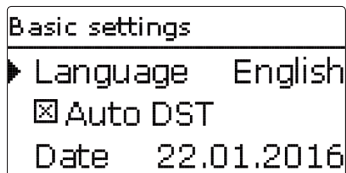

In the Basic settings menu, all basic parameters for the controller can be adjusted. Normally, these settings have been made during commissioning. They can be subsequently changed in this menu.

### Basic settings

Adjustment channel	Description	Adjustment range/selection	Factory setting
Language	Selection of the menu language	Deutsch, English, Francais, Soumi, České, Русский, Italiano, Español	Deutsch
Auto DST	Daylight savings time selection	Yes, No	Yes
Date	Adjustment of the current date	01.01.2001 ... 31.12.2099	01.01.2010
Time	Adjustment of the current time	00:00 ... 23:59	-
Temp. Unit	Temperature unit	°C, °F	-
Vol. Unit	Volume unit	Gallons, Liter	-
Press. Unit	Pressure unit	psi, bar	-
Energy Unit	Energy unit	Wh, kWh, BTU	-
Factory setting	back to factory settings	Yes, No	No

## 11 SD card

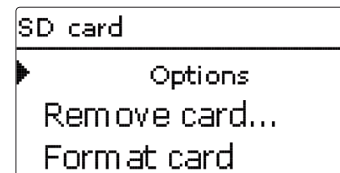

The controller is equipped with an SD card slot for SD memory cards.

With an SD card, the following functions can be carried out:

- Logging measurement and balance values in the txt format. After the transfer to a computer, the values can be opened and visualised, e. g. in a spreadsheet.
- Store adjustments and parameterisations on the SD card and, if necessary, retrieve them from there.
- Transferring firmware updates to the controller.

## Transferring firmware updates

When an SD card with a firmware update is inserted, the enquiry **Update?** is indicated on the display. The setting can be changed between **Yes** and **No** by pressing buttons 2 and 4.

→ To run the update, select **Yes** and confirm by pressing button 5.

The update is run automatically. The indication **Please wait** and a progress bar appear on the display. When the update has been transferred successfully, the controller will automatically reboot and run a short initialisation phase.

→ To skip the update, select **No**.

The controller commences normal operation.



### Note:

The controller will only recognise a firmware update file if it is stored in a folder named "OVENTROP/RXB" on the first level of the SD card.

→ Create a folder named "OVENTROP/RXB" on the SD card and extract the downloaded ZIP file into this folder.

## Starting the logging

→ Insert the SD card into the slot

→ Adjust the desired logging type and interval

Logging will start immediately.

## Stopping the logging

→ Select the menu item **Remove card**

→ After **Remove card** is displayed, remove the card from the slot.

When **Linear** is adjusted in the **Logging type** adjustment channel, data logging will stop if the capacity limit is reached. The message **Card full** will be displayed.

If **Cyclic** is adjusted, the oldest data logged onto the SD card will be overwritten as soon as the capacity limit is reached.



### Note:

Because of the increasing size of the data packets, the remaining logging time does not decrease linearly. The data packet size can increase, e. g. with the increasing operating hours value.

## Storing controller adjustments

→ To store the controller adjustments on an SD card, select the menu item **Save adjustments**.

While the adjustments are being stored, first **Please wait**, then **Done!** will be indicated on the display. The controller adjustments are stored as a .SET file on the SD card.

## Loading controller adjustments

→ To load controller adjustments from an SD card, select the menu item **Load adjustments**.

The File selection window is indicated.

→ Select the desired .SET file.

While the adjustments are being loaded, first **Please wait**, then **Done!** will be indicated on the display.

## Formatting the SD card

→ Select the menu item **Format card**.

The content of the card will be deleted and the card will be formatted with the FAT file system.



### Note:

To safely remove the SD card, always select the menu item **Remove card...** before removing the card.

## SD card

Adjustment channel	Description	Adjustment range/selection	Factory setting
Remove card...	Safely remove card	-	-
Save adjustments	Save adjustments	-	-
Load adjustments	Load adjustments	-	-
Logging interval	Logging interval	00:01 ... 20:00 (mm:ss)	01:00
Logging type	Logging type	Cyclic, Linear	cyclic
Format card	Format card	-	-



## 12 Manual mode

```

Manual mode
-----
      Controller
▶ Relay 1      Auto
  Relay 2      Auto
  
```

In the **Manual mode** menu, the operating mode of all relays in the controller and in connected modules can be adjusted.

All relays are displayed in numerical order, first those of the controller, then those of the individual modules connected. Modules are listed in numerical order.

In the menu item **All relays...**, all relays can be switched off (Off) or set to automatic mode (Auto) at once:

Off = Relay is switched off (manual mode)

Auto = Relay is in automatic mode

### Manual mode

Adjustment channel	Description	Adjustment range/ selection	Factory setting
All relays...	Operating mode of all relays	Auto, Off	Auto
Controller	-	-	-
Relay (1 ... 5)	Operating mode selection for the controller relays	Auto, Off	Auto
Module (1 ... 5)	-	-	-
Relay (1 ... 5)	Operating mode selection for the relays of modules connected	Max, Auto, Min, Off	Auto

```

Relay 1
-----
○ Max
▶ ● Auto
○ Min
  
```

The operating mode can be selected for each individual relay, too. The following options are available:

Off = Relay is switched off (manual mode)

Min. = Relay active with minimum speed (manual mode)

Max. = Relay active at 100% speed (manual mode)

Auto = Relay is in automatic mode



#### Note:

After service and maintenance work, the relay mode must be set back to **Auto**. Otherwise normal operation will not be possible.

If a relay is in manual mode, the control lamp will flash green.

## 13 User code

```

User code:
-----
      0000
      ▲
  
```

In the User code menu, a user code can be entered. Each number of the 4-digit code must be individually adjusted and confirmed. After the last digit has been confirmed, the menu automatically jumps to the superior menu level.

To access the menu areas of the expert level, the expert user code must be entered:

**Expert user code: 2962**

For safety reasons, the user code should generally be set to the customer code before the controller is handed to the customer!

**Customer user code: 0000**

If no entry is made in the User code menu for 30 min, the controller will automatically switch back to the customer level (0000).

## 14 In-/Outputs

In-/Outputs

▶ Modules

Inputs

Outputs

In the **In-/Outputs** menu, external modules can be registered, sensor offsets can be adjusted and relay outputs can be configured.

### 14.1 Modules

Modules

▶  Module 1

Module 2

Module 3

In this submenu, up to 5 Extension Modules „Regtronic EM“, Oventrop Article no. 1152098, can be registered. All modules connected and acknowledged by the controller are available.

➔ To register a module, select the corresponding menu item by pressing button .

The checkbox indicates the selection. If a module is registered, all its sensor inputs and relay outputs will be available in the corresponding controller menus.

### In-/Outputs/Modules

Adjustment channel	Description	Adjustment range/selection	Factory setting
Module 1 ... 5	Registering Extension Modules	-	-

## 14.2 Inputs

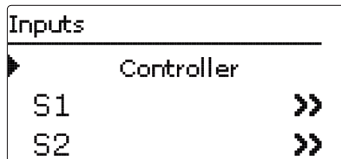

In this sub-menu, the type of the sensor connected can be adjusted for each individual input. The following types can be selected:

- Switch
- KTY
- Pt500
- RTA11M (remote control)
- Pt1000
- None

### ATTENTION! System damage!



Selecting the wrong sensor type will lead to unwanted control processes. In the worst case, system damage can occur!

→ **Make sure that the right sensor type is selected!**

If KTY, Pt500 or Pt1000 are selected, the channel **Offset** appears, in which an individual offset can be adjusted for each sensor.

→ In order to select a sensor for the offset adjustment, select the corresponding menu item by pressing button **5**.

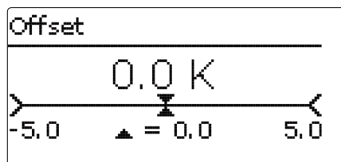

→ To adjust the sensor offset, select the desired value by pressing buttons **2** or **4**, then confirm by pressing button **5**.

## In-/Outputs/Inputs

Adjustment channel	Description	Adjustment range/selection	Factory setting
S1...S8	Sensor input selection	-	-
Type	Selecting the sensor type	Switch, KTY, Pt500, RTA11M, Pt1000, None	Pt1000
Offset	Sensor offset	-15.0... +15.0K	0.0K
CS10	CS10 input	-	-
Type	CS type	A...K	E
Offset	Delete offset	Yes, No	No
Imp.1	Impulse input	-	-
Type	Selecting the sensor type	Impulse, Switch, KTY, Pt500, RTA11M, Pt1000, None	Impulse
Gd (1,2)	Digital Grundfos sensor 1,2	-	-
Type	Grundfos sensor type	10-200 l/min, 5-100 l/min, 2-40 l/min (fast), 2-40 l/min, 1-20 l/min, 1-12 l/min	1-20 l/min
Mo(1...5) S(1...5)	Module sensor	-	-
Type	Selecting the sensor type	Switch, KTY, Pt500, RTA11M, Pt1000, None	Pt1000
Offset	Sensor offset	-15.0... +15.0K	0.0K

### Irradiation sensor offset

If an irradiation sensor is to be connected, an offset has to be carried out before the connection is made.

To carry out the offset, proceed as follows:

- Adjust the CS type in the **Type** channel.
- Select the **Offset** channel.
- Confirm the reset enquiry with Yes.
- Select back to return to the Inputs menu, then connect the CS sensor.

## 14.3 Outputs

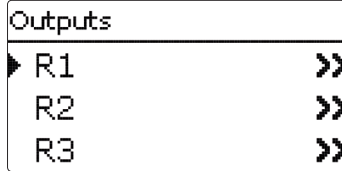

In this menu, the signal type and the minimum speed can be adjusted for each individual relay of the controller and the external modules.

➔ In order to make adjustments for a relay, select the corresponding menu item by pressing button

5.

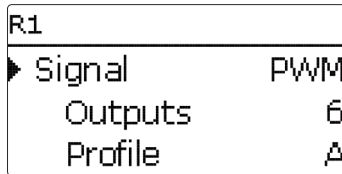

For each relay, the signal type and the minimum pump speed can be adjusted.

The signal type determines the way speed control of a connected pump is effected. The following modes are available:

Adapter = speed control signal via a S-Bus/PWM interface adapter

0-10V = speed control via a 0-10V signal

PWM = speed control via a PWM signal

Standard = burst control



### Note:

Speed-controlled high-efficiency pumps require two separate connections (pump connection cable for power supply, signal cable for transmitting the PWM/0-10V signal)

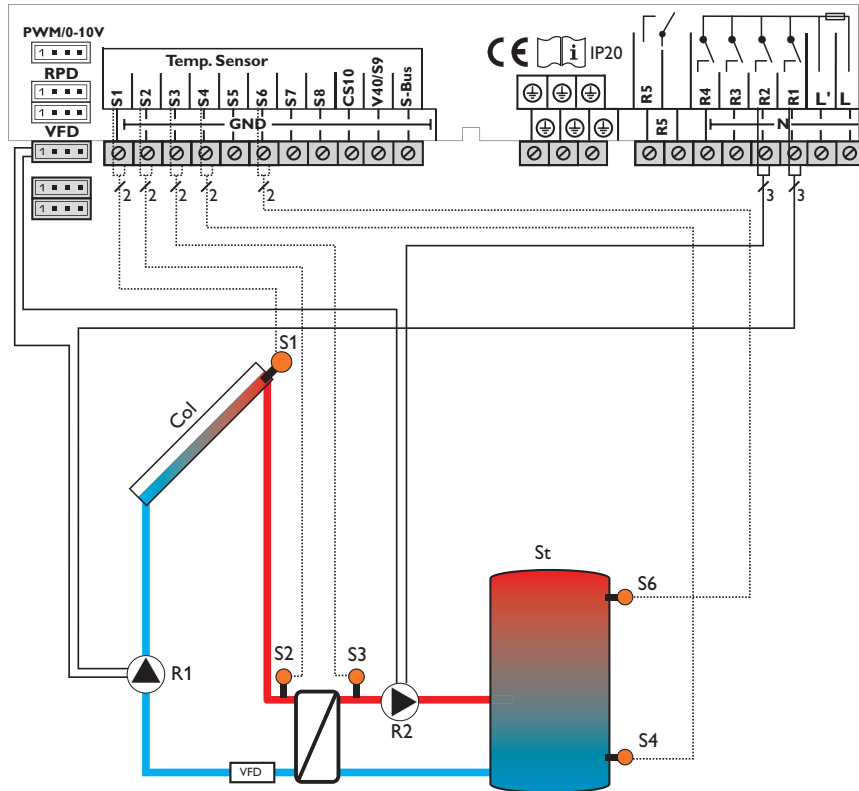

Example of the electrical connection of a high-efficiency pump

The relay only controls the power supply to the pump. The signal cable of the pump has to be connected to a signal output of the controller. The signal cable transmits the speed control signal to the pump in one of the possible signal types "Adapter", "0-10V" or "PWM". (see figure).

If PWM is selected, the channels Output and Profile appear. In the Output channel, one of the 2 PWM outputs can be selected. In the Profile channel, different PWM curves corresponding with the pump in use can be selected (see page 46).

In order to reduce the number of switching processes for high-efficiency pumps, the controller is equipped with a relay overrun function that automatically comes into effect when the speed control signal is not issued by the relay itself. The corresponding relay will then remain switched on for an hour after the switch-off conditions are fulfilled.



**Note:**

When the minimum pump speed value adjusted in the Outputs menu differs from the minimum pump speed adjusted in an optional function that uses the same output, only the higher value will be taken into account.

**In-/Outputs/Outputs**

Adjustment channel	Description	Adjustment range/selection	Factory setting
Controller	-	-	-
R1 ... R5	Relay output selection	-	-
Signal	Signal type	Adapter, 0-10V, PWM, Standard	Standard (R1, R2: PWM; R3: Adapter)
Output	PWM output selection	6,7	-
Profile	PWM curve	A, B, C, D, E, F	D
Min speed	Minimum speed	20% ... 100%	30%
Mo(1 ... 5)-R(1 ... 5)	-	-	-
Signal	Signal type	Adapter, 0-10V, PWM, Standard	Standard
Output	PWM output selection	PWM1, PWM2	-
Profile	PWM curve	A, B, C, D, E, F	D
Min speed	Minimum speed	30 ... 100%	30%

## 14.4 PWM profiles

### PWMA (e. g. manufacturer WILO)

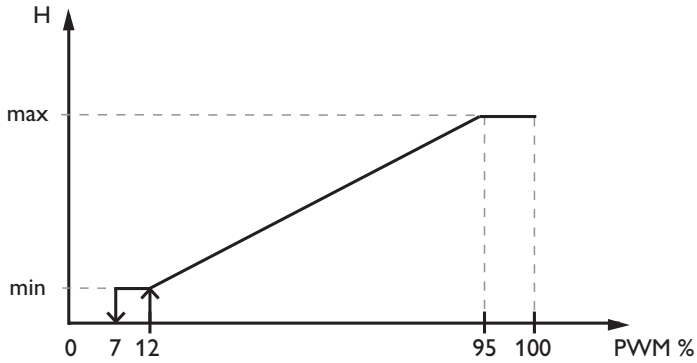

### PWMC (e. g. manufacturer Laing)

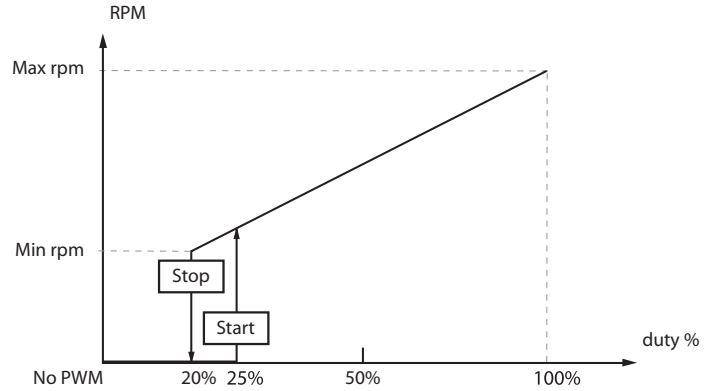

### PWMB (e. g. manufacturer Grundfos)

Solar PM Profile

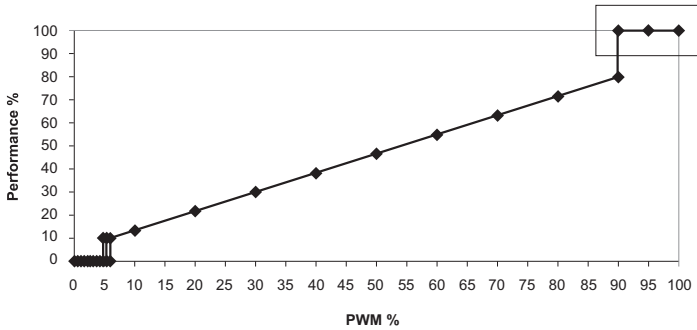

### PWMD (e. g. manufacturer WILO)

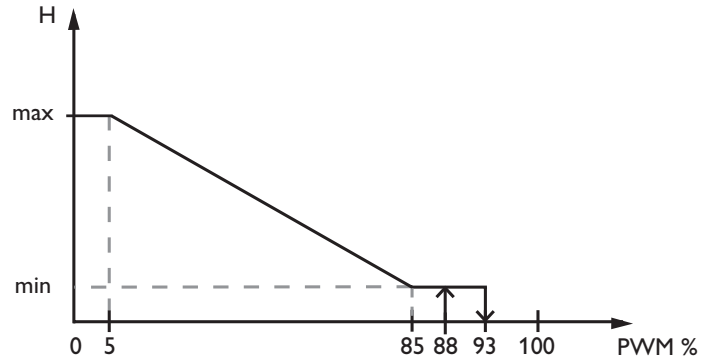

### PWM E (e. g. manufacturer Grundfos)

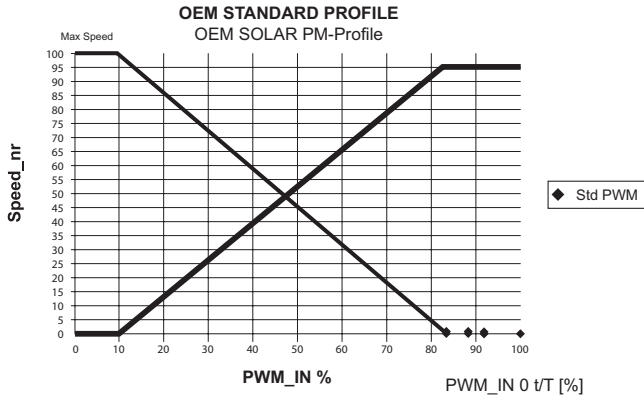

#### Note:

For PWM pumps, the adjustment range for the minimum speed begins at 20%. When a Laing pump is used (PWM C), a PWM starting impulse of at least 25% must be adjusted, in order for the pump to work at a minimum speed < 25%.

### PWM F (e. g. manufacturer Laing)

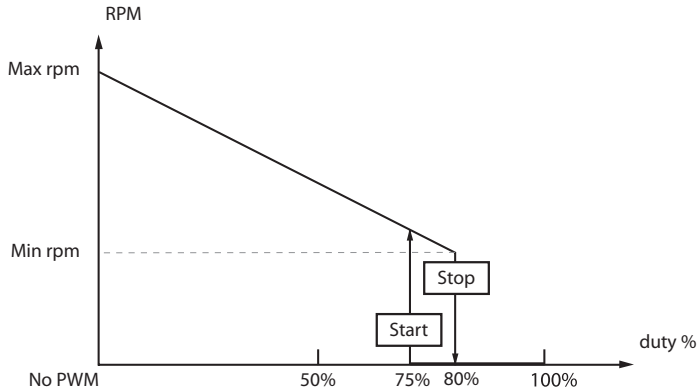

## 15 Troubleshooting

If a malfunction occurs, a message will appear on the display of the controller.



Fuse T4A

Directional pad flashes red.

Sensor fault. The message **!Sensor fault** instead of a temperature is shown on the sensor display channel.

Short circuit or line break

Disconnected temperature sensors can be checked with an ohmmeter. Please check if the resistance values correspond with the table.

°C	°F	Ω Pt500	Ω Pt1000	Ω KTY	°C	°F	Ω Pt500	Ω Pt1000	Ω KTY
-10	14	481	961	1499	55	131	607	1213	2502
-5	23	490	980	1565	60	140	616	1232	2592
0	32	500	1000	1633	65	149	626	1252	2684
5	41	510	1019	1702	70	158	636	1271	2778
10	50	520	1039	1774	75	167	645	1290	2874
15	59	529	1058	1847	80	176	655	1309	2971
20	68	539	1078	1922	85	185	664	1328	3071
25	77	549	1097	2000	90	194	634	1347	3172
30	86	559	1117	2079	95	203	683	1366	3275
35	95	568	1136	2159	100	212	693	1385	3380
40	104	578	1155	2242	105	221	702	1404	3484
45	113	588	1175	2327	110	230	712	1423	3590
50	122	597	1194	2413	115	239	721	1442	3695

### WARNING! Electric shock!



Upon opening the housing, live parts are exposed!

→ Always disconnect the device from power supply before opening the housing!

The controller is protected by a fuse. The fuse holder (which also holds the spare fuse) becomes accessible when the cover is removed. To replace the fuse, pull the fuse holder from the base.

The display is permanently off.

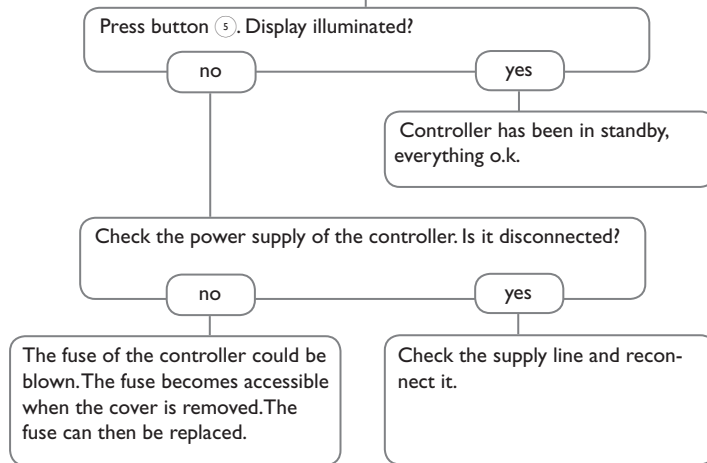



Pump is overheated, but no heat transfer from the collector to the store, flow and return have the same temperature; perhaps also bubbling in the lines.

Air or gas bubbles in the system?

yes

Vent the system; increase the system pressure to a static primary pressure of at least plus 0.5 bar; if necessary continue to increase pressure; switch the pump on and off for a short time.

Pump starts for a short moment, switches off, switches on again, etc.

Temperature difference at the controller too small?

no

yes

Change  $\Delta T_{on}$  and  $\Delta T_{off}$  correspondingly.

Wrong position of collector sensors?

no

yes

Mount the collector sensor at solar flow (warmest collector output); use immersion sleeve of the respective collector.

Plausibility control of the option tube collector special function

no

o.k.

Pump starts up very late.

Switch-on temperature difference  $\Delta T_{on}$  too large?

no

yes

Change  $\Delta T_{on}$  and  $\Delta T_{off}$  correspondingly.

Non-ideal position of the collector sensor (e. g. flatscrew sensor instead of sensor in immersion sleeves).

yes

Activate tube collector function if necessary.

o.k.

The temperature difference between store and collector increases enormously during operation; the collector circuit cannot dissipate the heat.

Collector circuit pump defective?

no

yes

Check/replace it

Heat exchanger calcified?

no

yes

Decalcify it

Heat exchanger blocked?

no

yes

Clean it

Heat exchanger too small?

no

yes

Replace with correctly sized one.

Heat transfer fluid has aged?

no

yes

Replace heat transfer fluid

Air inside the system?

yes

Vent the system

The solar circuit pump does not work, although the collector is considerably warmer than the store.

Display illuminated?

If not, press button (5). Display illuminated again?

yes no

There is no current; check fuses / replace them and check power supply.

Does the pump start up in manual operation?

no yes

The adjusted temperature difference for starting the pump is too high; choose a value which makes more sense.

Is the pump current enabled by the controller?

no yes

Controller might be defective - replace it.

Is the pump stuck?

yes

Dismount the pump and turn the pump shaft using a screwdriver; now passable?

no

Pump is defective - replace it.

Stores cool down at night.

Stores cool down at night.

no yes

Check the controller.

Collector temperature at night is higher than the outdoor temperature.

no yes

Check the functioning of the non-return valve(s).

Sufficient store insulation?

yes no

Increase insulation.

a

a

Insulation close enough to the store?

yes no

Replace insulation or increase it.

Are the store connections insulated?

yes no

Insulate the connections.

Warm water outflow upwards?

no yes

Change connection and let the water flow sideways or through a siphon (downwards); less store losses now?

no yes

o.k.

Does the DHW circulation run for a very long time?

no yes

Control the circulation pump via the Circulation optional function Therm. + Timer or implement a circulation pump with timer and switch-off thermostat (energy-efficient circulation).

Circulation pump and blocking valve should be switched off for 1 night; less store losses?

yes no

Check whether the pumps of the after-heating circuit run at night; check whether the non-return valve is defective; problem solved?

Check the non-return valve in warm water circulation - o.k.

yes no

no

The gravitation circulation in the circulation line is too strong; insert a stronger valve in the non-return valve or an electrical 2-port valve behind the circulation pump; the 2-port valve is open when the pump is activated, otherwise it is closed; connect pump and 2-port valve

Further pumps which are connected to the solar store must also be checked.

Clean or replace it.

electrically in parallel; activate the circulation again. Deactivate pump speed control!

## 16 Index

<b>A</b>			
Afterheating suppression.....	27	Measured values.....	19
Antifreeze, solar optional function.....	27	Minimum collector limitation.....	20
<b>B</b>		Modules, registration of.....	42
Balance values.....	19	<b>O</b>	
<b>C</b>		Offset.....	43
Circulation.....	34	Operating hours counter.....	19
Collector cooling, Cooling mode.....	28	Operating mode, relays.....	41
Collector emergency temperature.....	20	<b>P</b>	
Commissioning menu.....	11	Priority logic.....	21
Cooling mode.....	28	Progression chart.....	19
<b>D</b>		PWM pump speed control.....	44
$\Delta T$ function.....	36	<b>R</b>	
Data logging.....	40	Registering external modules.....	42
<b>E</b>		Return preheating.....	35
Error messages.....	19	<b>S</b>	
Error messages, acknowledgement of.....	19	Sensor fault, error message.....	19
Error relay.....	32	Sensor offset.....	43
<b>F</b>		Solid fuel boiler.....	33
Formatting the SD card.....	40	Store set temperature.....	21
Function block.....	36	Storing controller adjustments.....	40
Fuse, replacing of.....	48	System cooling, Cooling mode.....	28
<b>H</b>		<b>T</b>	
Heat dump.....	29, 30	Technical data.....	4
Heat quantity measurement.....	38	Thermostat function.....	36
Holiday function.....	28	Timer.....	9
<b>L</b>		Tube collector function.....	26
Loading controller adjustments.....	40	<b>U</b>	
<b>M</b>		User code.....	41
Mains connection.....	6		
Manual mode.....	41		
Maximum store temperature.....	21		

Subject to technical modification without notice.

136109582 04/2016

OVENTROP GmbH & Co. KG  
Paul-Oventrop-Straße 1  
D-59939 Olsberg  
Telephone +49 (0) 29 62 82-0  
Fax +49 (0) 29 62 82-400  
E-mail [mail@oventrop.de](mailto:mail@oventrop.de)  
Internet [www.oventrop.com](http://www.oventrop.com)

For an overview of our global  
presence visit [www.oventrop.com](http://www.oventrop.com).